



NED University of Engineering & Technology
Department of Electrical Engineering

LAB MANUAL
For the course

ELECTRICAL POWER SYSTEM PROTECTION
(EE-457) For B.E.(EE)

Instructor name: _____

Student name: _____

Roll no: _____ **Batch:** _____

Semester: _____ **Year:** _____

To be filled by lab technician

Attendance: Present out of _____ Lab sessions

Attendance Percentage _____

To be filled by Lab Instructor

Lab Score Sheet

Roll No.	Rubric based Lab I	Rubric based Lab II	Rubric based Lab III	Rubric based Lab IV	Rubric based Lab V	Rubric based Lab VI	OEL/PBL Rubric Score A	Final LAB Rubric Score B	Attendance Percentage C	Final weighted Score for MIS System [10(A)+10(B)+5(C)]/25 Round to next higher multiple of 5

Rubric based labs for EE-457 EPSP: 2, 3, 4, 8, 9, 10

Note: All Rubric Scores must be in the next higher multiple of 5 for correct entry in MIS system.

LAB MANUAL

For the course

ELECTRICAL POWER SYSTEM PROTECTION **(EE-457) For B.E. (EE)**

Content Revision Team:

Mr. Adnan Ali (Assistant Professor, EED)

Mr. Muhammad Farooq Siddiqui (Lecturer, EED)

Ms. Hiba Kamal Zuberi (Lecturer, EED)

Last Revision Date: 29th December, 2020

Approved By

The Board of Studies of Department of Electrical Engineering

EE-457 (Electrical Power System Protection)

About this Lab:

In this lab, the operational features of Relays both Static and Numerical Relays will be learned. The broad category of relays includes over voltage, under voltage, frequency, asymmetry, over current, short circuit relays and various measurement as well. Students will use them extensively during the entire semester.

Student will learn to operate a generation set and its control board and connection with load bank and then relays will be applied on this generation set to see the tripping for phase detection, phase failure and load unbalancing (% asymmetry) also the working will be checked for min voltage and max voltage relay, min frequency and max frequency relay and over load and short circuit relay. Then the line synchronization (generator & KE supply) will be performed in the smart grid laboratory and on this power system simulator panel the performance and operating environment of following relays will be checked overcurrent protection on REF-615, RET-630 (voltage & frequency protection), differential relay (ABB-RET 615) and using this differential relay the protection of a Dy connected transformer will be carried out.

You will be communicated **OPEN ENDED LABS** at the start of the session which will be evaluated at the respective weeks during the session. In these labs, students will be working in group of 2-5 students to develop, investigate and perform experiments and submit lab report accordingly.

Lab Assessment:

All labs will be evaluated according to the decided rubrics individually and then the final score will be calculated. The lab marking rubrics are attached on the separate page at the starting of each lab.

At the end of this lab:

After the successful completion of lab tasks, student will be able to:

- Understand the key operational features of motor-generator set and power system simulator available in the power system lab and smart grid laboratory.
- To check the working of various relays including relay for phase detection, phase failure and load unbalancing (% asymmetry) min voltage and max voltage relay, min frequency and max frequency relay and over load and short circuit relay.
- Have good understanding of the environment and parameter setting for numerical relays including overcurrent protection on REF-615, RET-630 (voltage & frequency protection) and differential relay (ABB-RET 615).
- Develop ability to think logically, design and verify the results of developed experiments through open ended labs.

EE-457 (Electrical Power System Protection)**CLO assessment methods, KPIs**Course Code: - EE-457 Course Title: - Electrical Power System ProtectionDepartment: - Electrical Engg.Semester: - Fall 2018

Domain/Taxonomy level	Assessment Method	KPI	Timeline for evaluation
Psychomotor Level 3	Lab demonstration which will be evaluated as per decided lab rubrics	<u>Individual:</u> >50% will be considered as Average <u>Cohort level:</u> >=60% will be considered as Good	At the end of every lab

CONTENTS

S.No.	Date	Psychomotor / Cognitive Level	CLO/ PLO	Title of Experiment	Signature
01			4/4	To operate a generation set and its control board and connection with load bank	
02			4/4	To apply a relay for phase detection, phase failure and load unbalancing (% asymmetry)	
03			4/4	To check the working and functions of min voltage and max voltage relay	
04			4/4	To check the working and functions of min frequency and max frequency Relay	
05			4/4	<u>Open Ended Lab:</u> To check the working and functions of overload and short circuit relay.	
06			4/4	To check the working of alarm relay.	
07			4/4	To check operation of potential transformer and calculate error of potential transformer	
08			4/4	Line synchronization (generator & KE supply)	
09			4/4	To perform voltage & frequency protection on RET-630 relay	
10			4/4	To perform overcurrent protection on REF-615 relay.	
11			4/4	<u>Open Ended Lab:</u> To check the working and functions of ABB REF-615 relay for earth fault settings.	
12			4/4	Introduction to the operating environment of differential relay (RET 615).	
13			4/4	To perform the differential protection of a Dy connected transformer using RET 625 relay.	

SAFETY RULES



1. Please don't touch any live parts.
2. Never use an electrical tool in a damp place.
3. Don't carry unnecessary belongings during performance of practicals (like water bottle, bags etc).
4. Before connecting any leads/wires, make sure power is switched off.
5. In case of an emergency, push the nearby red color emergency switch of the panel or immediately call for help.
6. In case of electric fire, never put water on it as it will further worsen the condition; use the class C fire extinguisher.

Fire is a chemical reaction involving rapid oxidation (combustion) of fuel. Three basic conditions when met, fire takes place. These are fuel, oxygen & heat, absence of any one of the component will extinguish the fire.

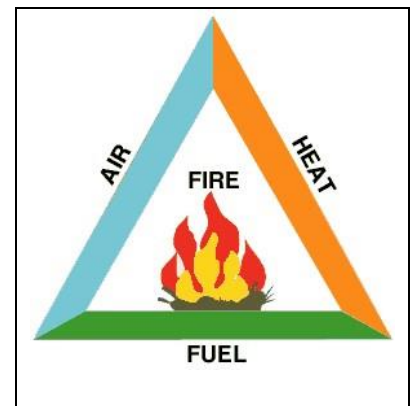
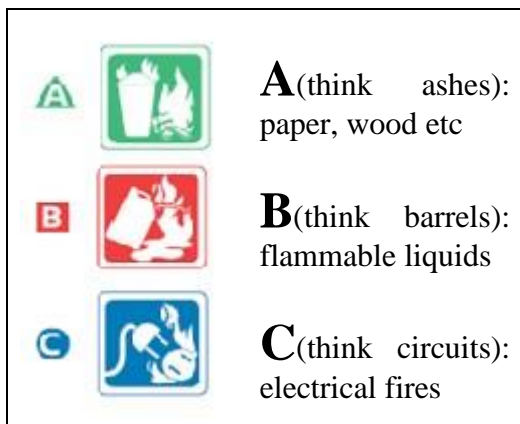

Figure: Fire Triangle



If there is a small electrical fire, be sure to use only a Class C or multipurpose (ABC) fire extinguisher, otherwise you might make the problem worsen.

The letters and symbols are explained in left figure. Easy to remember words are also shown.

Don't play with electricity, Treat electricity with respect, it deserves!

LAB SESSION 01**TITLE:**

To operate a generation set and its control board and Connection with Load Bank

APPARTUS:

- Control board for generation set mod. GCB-1/EV.
- Synchronous generator-motor set mod. MSG-1/EV.
- Variable resistive load mod. RL-2/EV.
- Variable inductive load mod. IL-2/EV.
- Set of cables-jumpers for electrical connections.

THEORY:**1. DESCRIPTION OF THE SET:**

The generation set consists of a common base, a DC motor and a synchronous Generator with rotating inductor coupled n between them. The Prime Mover is provided with Tacho generator for control and stabilization of rotation speed.

2. DC MOTOR:

Nominal Power =1000W, Armature Voltage = 170V dc, Rotation Speed = 3000 RPM, Separately excited and field series compensation, tacho generator 0.06 Vdc /rev coupled to motor.

3. SYNCHRONOUS THREE PHASE GENERATOR

Nominal Power =1000VA, Armature Connection = 3 x 230/400 V ac, Rotation Speed = 3000 RPM, Separately excited 220 V dc, Delta /Star Connection

PROCEDURE:

1. Carefully connect each machine and the left side silk screen panel on the board GCB1/EV of the electrical power supply. All Connections must be made with equipment's off, use the provided 2-m safety cables; and Pay special attention to the polarities.
2. Connect the tacho-generator (TG), terminals + and – of the output 0.06 rev, to side panel of GCB -1/EV (1 red cable and 1 black one).
3. Connect the DC motor thermal protector (M) to the same terminals of the side panel of the GCB-1/EV (2 red cables). Note that without this electrical continuity the DC motor drive keeps in stand-by
4. Connect the DC motor field (M), terminals F1-F2, to the side panel of the GCB-1/EV (1 red and 1 black cable).
5. Connect the DC motor armature (M), terminals A1-A2, to the side panel of the GCB1/EV (1 red and 1 black cable).

6. Connect the thermal protector of the synchronous generator ($G3\sim$) to the same terminals of the side panel of the GCB-1/EV (2 red cables). Be sure this electrical continuity is reported on the front panel and is used to release the parallel contactor, in case of over temperature of the synchronous generator, coupled to the protection relays.
7. Connect the excitation circuit of the synchronous generator ($G3\sim$), terminal F1-F2, to the side panel of the GCB 1/EV (3 black cables) and the three terminals U2-V2-W2 Connected together, to the terminal N of the side panel of the GCB-1/EV (1 blue cable) Attention such conductor becomes the neutral.
8. Connect all machines to the protection ground (Side Panel of the GCB-1/EV, PE terminal) using yellow cables.
9. Connect to ground even the star center of the synchronous generator to create a TN system.

1. STARTING THE GENERATION SET:

1. Switch ON the K.E. supply (i.e. 1 Φ 220V, 50Hz)
2. Move selector switch from “0” to “1” position. The indication marked as “Line” on GCB-1/EV control board will turn “ON”.
3. Move the button of motor drive from “Stand by” to “Run”.
4. Adjust the excitation voltage of three phase generator from control board so that the terminal voltage of three phase generator becomes 400V. 5. Adjust the speed of DC motor Drive for 50Hz frequency.

2. HALTING THE GENERATION SET:

The halting procedure for the generator set should be made in the reverse order from starting procedure

1. Elimination of the excitation Voltage of Synchronous Generator
2. Load Separation
3. Prime mover halting i.e. RPM potentiometer to zero and RUN/ STAND BY switch to STAND BY.

OBSERVATIONS:

LAB SESSION 02

TITLE:

To apply a relay for phase detection, phase failure and load unbalancing (% asymmetry)

APPARTUS:

- Control board for generation set mod. GCB-1/EV.
- Synchronous generator-motor set mod. MSG-1/EV.
- Module SR6 Presence, Asymmetry And Sequence Failure Relay ▪ Variable resistive load mod. RL-2/EV.
- Variable inductive load mod. IL-2/EV.
- Set of cables-jumpers for electrical connections.

THEORY:

The relay for phase sequence and three-phase voltage asymmetry detects that the triad of voltages is the fixed direction. In the operation of parallel with the network and/or with other alternators, the relay does not enable the main switch for synchronous generator parallel to close if this is not fitting.

In the line, it detects the voltage asymmetries, occurring, e.g., for too unbalanced load. Its action prevents dangerous over voltages to the synchronous generator. To fulfill the purpose, the asymmetry value and the related delay time can be adjusted. The set values must be checked during the test phase and then in the periodical tests to be sure of the protection device operation. The tolerated asymmetry values and the delay times are project data and must be available for the tests.

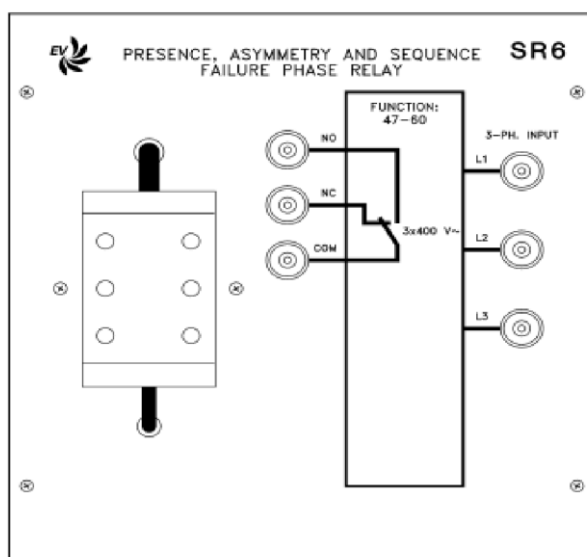

Figure 1

Module's description

3-PH INPUTS Input terminals of the line to be monitored, range 3 x 400 Vac.

NO-NC-COM Terminals with output contact exchange for sequence and/wrong asymmetry alarm. The state of the contacts is referred to the device with auxiliary power supply present and not in alarm.

The auxiliary power supply is not necessary as it powers itself from the control line. If a phase-to-phase concatenated voltage 3 x 230 V is available, it is necessary to interpose some VT (voltage transformers) 230/400 adapters.

Device Technical Characteristics

- ✓ Relay for phase sequence, phase lacking and voltage asymmetry for three-phase network 3 x 400 V
- ✓ Asymmetry regulation with rotary potentiometer from the 5 to the 15 % with intervention after the DELAY time and automatic canceling when the unbalance drops under the 1% of the set point.
- ✓ Intervention time adj. with DELAY potentiometer from 0.1 to 10 s.
- ✓ Instantaneous intervention for phase lack and wrong phase sequence.
- ✓ Intervention for network frequency variation over the 5%.
- ✓ Power supply from the measurement circuit.
- ✓ Normally energized state of the relay (de-energized at the intervention).
- ✓ Led ON indicating the power supply presence.
- ✓ Led RELAY indicating the intervention (in alarm it turns off).

REGULATION

Suppose and adjust the device with the following project data:

- ✓ ASYMMETRY = 10 %;
- ✓ intervention delay in asymmetry (DELAY) = 5 s;

PROCEDURE:

1. Activate the prime mover and adjust the synchronous generator to the frequency and nominal voltage to provide the relay with the power supply voltage 3 x 400 V (nominal voltage). If the phase sequence is correct, not only the led ON must be ON but also the RELAY led. On the contrary, the two conductors coming from the generator must be inverted on themselves. When the RELAY led is on, the relay for phase sequence and three-phase voltage asymmetry is properly powered and shows no alarm.
2. With the multimeter in Ohm, check the state of the output relay contacts (they correspond to the diagram shown on the panel in ordinary conditions, proper phase sequence and symmetrical voltages).
3. Invert two phases of the power supply triad on themselves and check the output relay does not give its consent anymore (interruption of the continuity displayed with the multimeter).
4. Reset the ordinary condition and cut off a phase of the triad of voltages under control and check the **instantaneous** intervention of the output relay (signaled by the interruption of continuity in the multimeter and by the switching off of the RELAY led). To interrupt a phase, disconnect, e.g., the U1 cable of the synchronous generator on the left side panel.

5. Complete the wiring involving the step resistive load mod. RL-2/EV. The load must be connected to the output terminals of the digital instrument identified by the letters L1-L2L3-N. Be sure that all switches of the steps of each phase are in excluded load conditions (OFF).
6. Set the synchronous generator under load with the insertion of the first step of the resistive module (carry out an unbalanced load), the voltage drop of the phase loaded in respect to the other two represents an asymmetry and if its value exceeds the threshold value of the 10 % the relay signals the fault. The three voltages can be displayed cyclically on the analog voltmeter and also on the digital one
7. The relay intervention by asymmetry, after the fixed time delay, is signaled by the switching off of the RELAY led, its canceling is automatic when the parameters return inside the limits of the made regulation.
8. The above made asymmetry corresponds to a lower phase in respect to the other two, now insert also the first step of the second phase of the resistive module and compensate the voltage of the two loaded phases. The asymmetry corresponds to a higher phase in respect to the other two.
9. Repeat the intervention testing for asymmetry with other voltage and delay values.

The relay consent for phase sequence, phase lacking and voltage asymmetry, via the clean contact of its inner relay (NC contact), can be included in the safeties to enable the parallel between generators or with the public power mains.

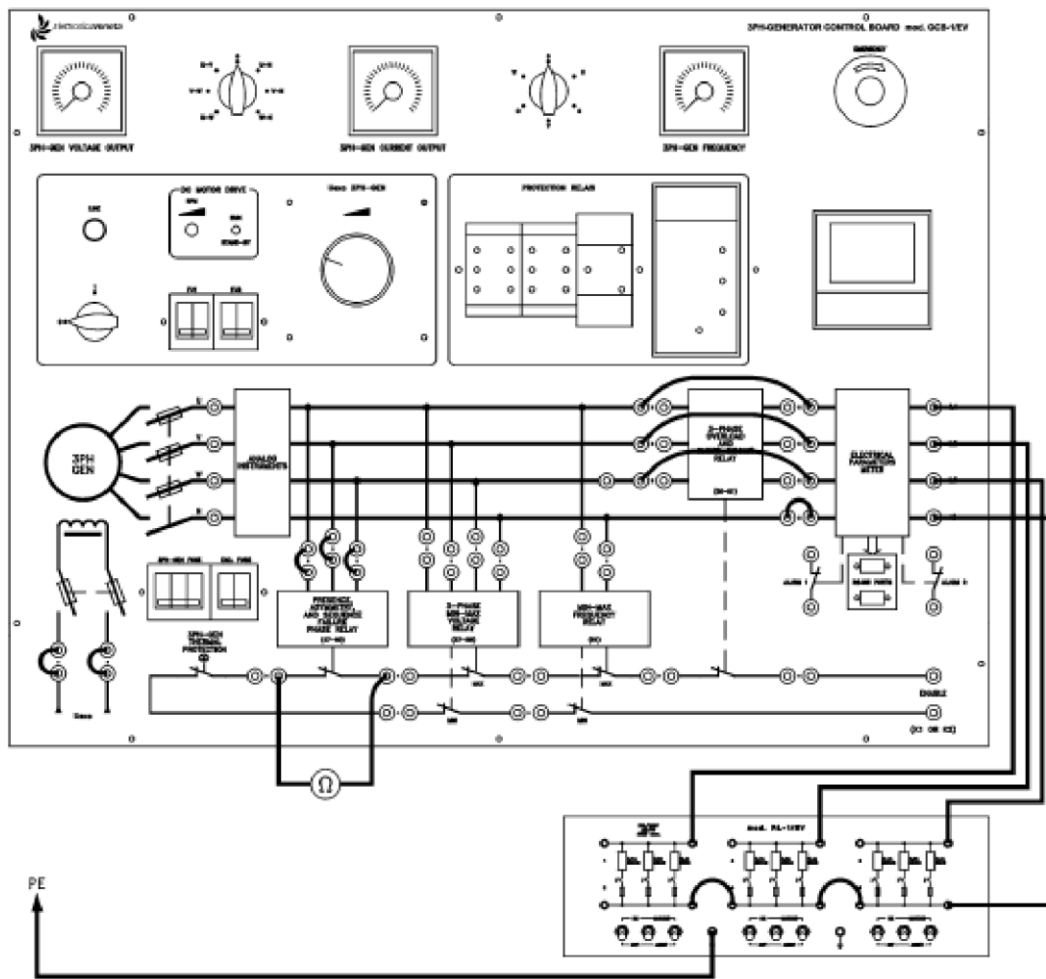

Connections on the board GCB-1/EV.

Figure 2 Operation test of the relay for phase sequence, phase lacking and voltage asymmetry



Course Code and Title: _____

Laboratory Session: No. _____ Date: _____

Psychomotor Domain Assessment Rubric-Level P3					
Skill Sets	Extent of Achievement				
	0	1	2	3	4
Equipment Identification Sensory skill to identify equipment and/or its component for a lab work. 10%	Not able to identify the equipment. 0	--	--	--	Able to identify equipment as well as its components. 40
Equipment Use Sensory skills to describe the use of the equipment for the lab work. 15%	Never describes the use of equipment. 0	Rarely able to describe the use of equipment. 15	Occasionally describe the use of equipment. 30	Often able to describe the use of equipment. 45	Frequently able to describe the use of equipment. 60
Procedural Skills Displays skills to act upon sequence of steps in lab work. 15%	Not able to either learn or perform lab work procedure. 0	Able to slightly understand lab work procedure and perform lab work. 15	Able to somewhat understand lab work procedure and perform lab work. 30	Able to moderately understand lab work procedure and perform lab work. 45	Able to fully understand lab work procedure and perform lab work. 60
Response Ability to imitate the lab work on his/her own. 15%	Not able to imitate the lab work. 0	Able to slightly imitate the lab work. 15	Able to somewhat imitate the lab work. 30	Able to moderately imitate the lab work. 45	Able to fully imitate the lab work. 60
Observation's Use Displays skills to perform related mathematical calculations using the observations from lab work. 15%	Not able to use lab work observations into mathematical calculations. 0	Able to slightly use lab work observations into mathematical calculations. 15	Able to somewhat use lab work observations into mathematical calculations. 30	Able to moderately use lab work observations into mathematical calculations. 45	Able to fully use lab work observations into mathematical calculations. 60
Safety Adherence Adherence to safety procedures. 10%	Doesn't adhere to safety procedures. 0	Slightly adheres to safety procedures. 10	Somewhat adheres to safety procedures. 20	Moderately adheres to safety procedures. 30	Fully adheres to safety procedures. 40
Equipment Handling Equipment care during the use. 10%	Doesn't handle equipment with required care. 0	Rarely handles equipment with required care. 10	Occasionally handles equipment with required care. 20	Often handles equipment with required care. 30	Handles equipment with required care. 40
Group Work Contributes in a group-based lab work. 10%	Never participates. 0	Rarely participates. 10	Occasionally participates and contributes. 20	Often participates and contributes. 30	Frequently participates and contributes. 40
Total Points (Out of 400)					
Weighted CLO (Psychomotor Score)		(Points /4)			
Remarks					
Instructor's Signature with Date:					

LAB SESSION 03

TITLE:

To check the working and functions of Min voltage and Max voltage relay

APPARTUS:

- Control board for generation set mod. GCB-1/EV.
- Synchronous generator-motor set mod. MSG-1/EV. ▪ Module SR3 3-Phase MIN-MAX VOLTAGE RELAY
- Variable resistive load mod. RL-2/EV.
- Variable inductive load mod. IL-2/EV.
- Set of cables-jumpers for electrical connections.

THEORY:

The three-phase voltage detects the limit of the triad of voltage generated in ordinary service by the synchronous generator or distributed to the transmission line. Usually, the relay, acts on the main switch to set the controlled object out of service (synchronous generator or user connected to the line) when a voltage rise or drop can cause malfunctions or damages. To fulfill the purpose, the max/min voltage value as well as the related delay times can be adjusted. The set values must be checked in the testing phase and next in the periodical test to be sure of the protection device operation. The tolerated max/min voltage values and the delay times are project data and must be available for the tests.

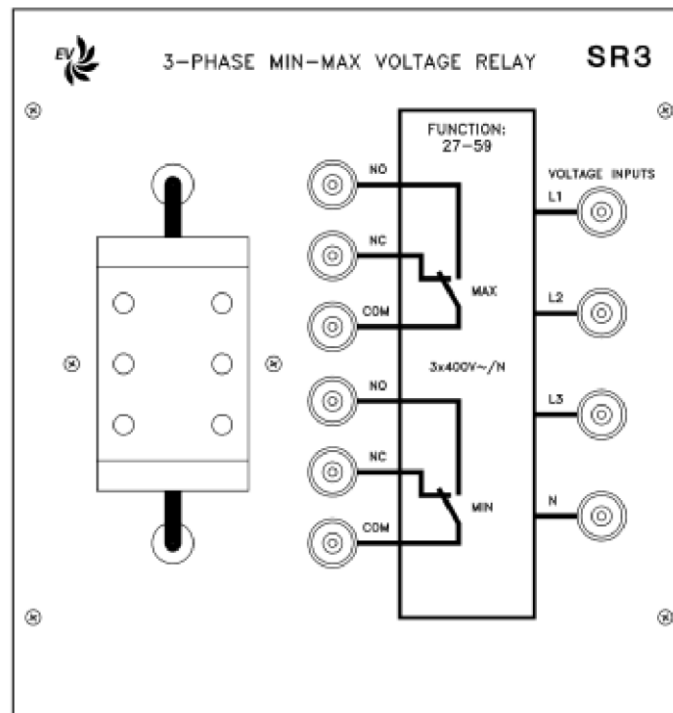

Figure 1

Module's description**VOLTAGE INPUTS**

Input terminals of the triad of three-phase voltage with neutral, range 400 Vac.

**NO-NC-COM
MAX**

Terminals with contacts of the high voltage alarm output relay. The state of the contacts is referred to the device with auxiliary power supply present and not in alarm.

**NO-NC-COM
MIN**

Terminals for output relay contacts for low voltage alarm. The state of the contacts is referred to the device with auxiliary power supply present and not in alarm.

The auxiliary power supply is not necessary as it self-powers from the measurement.

**Device Technical
Characteristics**

- ✓ Max/min voltage voltmeter relay for three-phase 400-V line with neutral.
- ✓ Switch of the nominal value of the line to be checked 380, 400, 415 Vac + 10% / -15%.
- ✓ Intervention threshold regulation for overvoltage MAX VOLTAGE from 102 to 110%.
- ✓ Intervention time regulation for overvoltage DELAY MAX from 0.1 to 10 s.
- ✓ Intervention threshold regulation for undervoltage MIN VOLTAGE from the 85 to the 98 %.
- ✓ Intervention time regulation for undervoltage DELAY MIN from 0.1 to 10 s.
- ✓ Power supply from the measurement circuit.
- ✓ Automatic canceling when the voltage returns inside the fixed parameters.
- ✓ Normally energized state of the relays, de-energized at the intervention.
- ✓ Led ON indicating the power supply presence.
- ✓ Led MAX indicating the maximum voltage intervention. ✓ Led MIN indicating the minimum voltage intervention.

REGULATIONS

Suppose and adjust the device with the following project data:

- ✓ nominal voltage of the network $U_e = 400$ V
- ✓ maximum voltage threshold (MAX VOLTAGE) = 105 %
- ✓ maximum voltage intervention delay (DELAY MAX) = 5 s ✓ minimum voltage threshold (MIN VOLTAGE) = 90 % ✓ minimum voltage intervention delay (DELAY MIN) = 5 s.

PROCEDURE:

1. Activate the prime mover and adjust the synchronous generator to the frequency and nominal voltage to provide the relay with the power supply voltage 3 x 400 V (nominal voltage). In this condition the voltmeter relay is properly powered and shows no alarm.
2. Connect the multimeter set to Ohm alternatively to the NC contacts of the max/min voltage output relay and check the correspondence of the contacts (they corresponds to the diagram shown on the panel in ordinary conditions, voltage in the limits).

3. Increase the voltage supplied by the synchronous generator to about 430 V, record the time between the “overvoltage” moment and the same output relay tripping one (signaled by the interruption of continuity in the multimeter). If the delay time and the maximum voltage intervention values are not those supposed, adjust with the proper regulations in the device.
4. Take back the voltage to nominal value (400 V) and check the alarm cancels (the maximum voltage output relays cancel). Consider that the relay has an hysteresis of the 3% in respect to the set point. This means the relay cancelling occurs at ≈ 410 V.
5. Drop the voltage provided by the synchronous generator to about 350 V, record the time between the “under voltage” moment and the same output relay tripping one (signaled by the interruption of continuity in the multimeter). If the delay time and the minimum voltage intervention values are not those supposed, adjust with the related adjustments in the device
6. Take back the voltage to the nominal value (400 V) and check the “alarm” cancels (the minimum voltage output relay cancels). Consider the relay has an hysteresis of the 3% in respect to the set point. This means the relay canceling occurs at ≈ 370 V.
7. Repeat the intervention tests for max/min voltage with other voltage and delay values.
8. The relay tripping for maximum voltage alarm, at the end of the given delay, is signaled by the lighting on of the MAX Led, the relay cancels when the voltage returns under the fixed value.
9. The relay tripping for minimum voltage alarm, at the end of the given delay, is signaled by the lighting on of the MIN led, the relay cancels when the voltage rises over the fixed value.
10. In alternative to what described above, to demonstrate the minimum voltage relay tripping, complete the wiring including the step resistive load mod. RL-2/EV. The load must be connected to the output terminals of the digital instruments identified by the letters L1-L2L3- N. Be sure that all step switches of each phase are in excluded load position (OFF).
11. Set the synchronous generator under load with the insertion of the first step of the resistive module (carry out a balanced load) if the voltage drop value exceeds the threshold value of 10 % set in the device, the relay signals the fault. The triad of voltages can be displayed cyclically on the analog voltmeter and in case in the digital one, too.

The max/min voltage relay consents, via clean contacts on its inner relays (NC contacts), can be included in the safeties to enable and keep the parallel of the generator with the public power mains or with another generator.

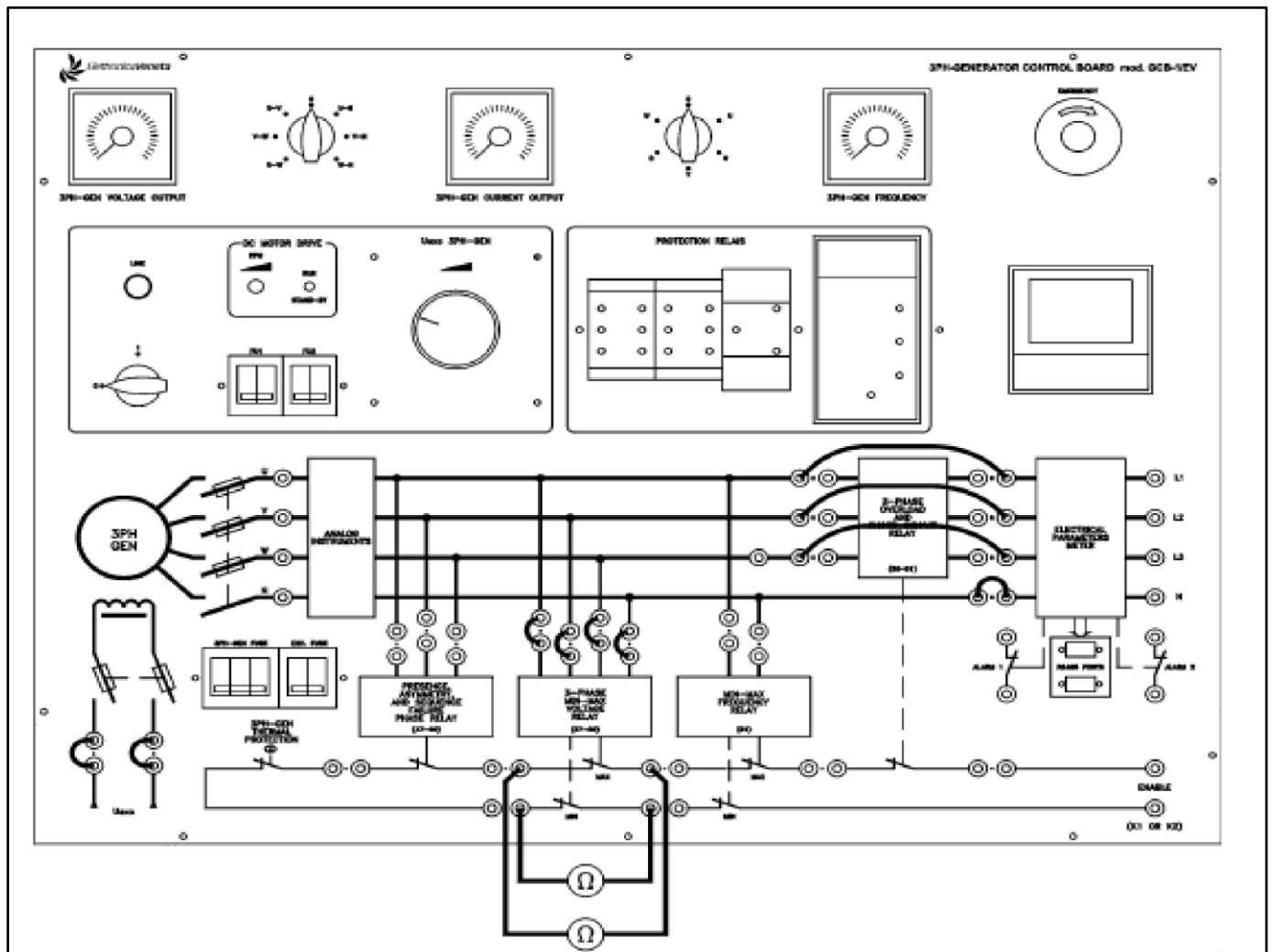

Connections on the board GCB-1/EV.

Figure 2 Operation test of the max/min three-phase voltage relay



Course Code and Title: _____

Laboratory Session: No. _____ Date: _____

Psychomotor Domain Assessment Rubric-Level P3					
Skill Sets	Extent of Achievement				
	0	1	2	3	4
Equipment Identification Sensory skill to identify equipment and/or its component for a lab work. 10%	Not able to identify the equipment. 0	--	--	--	Able to identify equipment as well as its components. 40
Equipment Use Sensory skills to describe the use of the equipment for the lab work. 15%	Never describes the use of equipment. 0	Rarely able to describe the use of equipment. 15	Occasionally describe the use of equipment. 30	Often able to describe the use of equipment. 45	Frequently able to describe the use of equipment. 60
Procedural Skills Displays skills to act upon sequence of steps in lab work. 15%	Not able to either learn or perform lab work procedure. 0	Able to slightly understand lab work procedure and perform lab work. 15	Able to somewhat understand lab work procedure and perform lab work. 30	Able to moderately understand lab work procedure and perform lab work. 45	Able to fully understand lab work procedure and perform lab work. 60
Response Ability to imitate the lab work on his/her own. 15%	Not able to imitate the lab work. 0	Able to slightly imitate the lab work. 15	Able to somewhat imitate the lab work. 30	Able to moderately imitate the lab work. 45	Able to fully imitate the lab work. 60
Observation's Use Displays skills to perform related mathematical calculations using the observations from lab work. 15%	Not able to use lab work observations into mathematical calculations. 0	Able to slightly use lab work observations into mathematical calculations. 15	Able to somewhat use lab work observations into mathematical calculations. 30	Able to moderately use lab work observations into mathematical calculations. 45	Able to fully use lab work observations into mathematical calculations. 60
Safety Adherence Adherence to safety procedures. 10%	Doesn't adhere to safety procedures. 0	Slightly adheres to safety procedures. 10	Somewhat adheres to safety procedures. 20	Moderately adheres to safety procedures. 30	Fully adheres to safety procedures. 40
Equipment Handling Equipment care during the use. 10%	Doesn't handle equipment with required care. 0	Rarely handles equipment with required care. 10	Occasionally handles equipment with required care 20	Often handles equipment with required care. 30	Handles equipment with required care. 40
Group Work Contributes in a group-based lab work. 10%	Never participates. 0	Rarely participates. 10	Occasionally participates and contributes. 20	Often participates and contributes. 30	Frequently participates and contributes. 40
Total Points (Out of 400)					
Weighted CLO (Psychomotor Score)		(Points /4)			
Remarks					
Instructor's Signature with Date:					

LAB SESSION 04

TITLE:

To check the working and functions of Min Frequency and Max Frequency relay

APPARTUS:

- Control board for generation set mod. GCB-1/EV.
- Synchronous generator-motor set mod. MSG-1/EV.
- Module SR5 MIN-MAX FREQUENCY RELAY
- Set of cables-jumpers for electrical connections.

THEORY:

The relay enables the max/min frequency control of the alternated power generated by the synchronous generator in ordinary service. As protection device, it acts on the main switch of the synchronous generator.

It is used to protect the synchronous generator in case of over or under speed of the prime mover. The set values must be checked during the testing phase and next in the periodical tests to be sure of the protection device operation. The frequency limits and the delay times are project data and must be available for the tests.

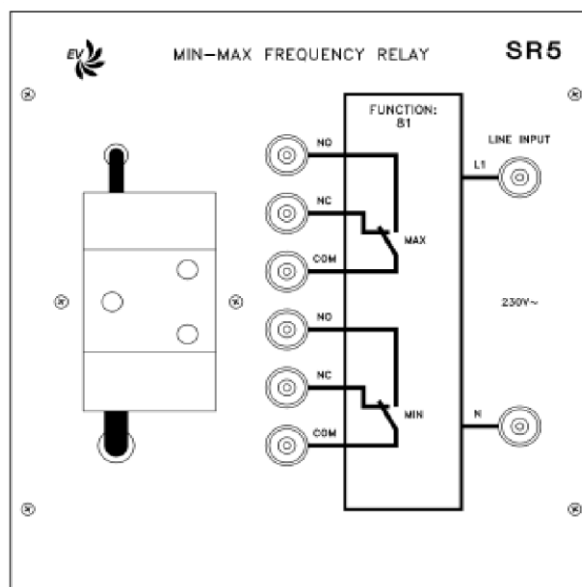

Figure 1 MIN- MAX Frequency Relay

Module's description

- LINE INPUTS** Input terminals for the Neutral line voltage input, range 230 Vac.
- NO-NC-COM** Terminals for output relay exchange contacts for the high frequency alarm.

MAX	The state of the contacts is referred to the device with present power supply and not in alarm.
NO-NC-COM	Terminals for output relay contacts for low frequency alarm.
MIN	The state of the contacts is referred to the device with present power supply and not in alarm.

The auxiliary power supply is not necessary as it is self-powered by the measurement. The relay can be phase-to-phase connected with lines having concatenated voltage 3x230V, too.

If only the phase-to-phase concatenated voltage is available 3 x 400 V, it is necessary to interpose a VT (volt-metric transformer) 400/230 reducer.

Device Technical

Characteristics ✓ Max/min frequency relay.

- ✓ Nominal power supply: 230 Vac \pm 15%.
- ✓ **FREQ.** switch for lines with frequency of 50 or 60 Hz.
- ✓ Max. Frequency intervention threshold regulation with rotary switch from 0.5 to 10 Hz.
- ✓ Max. Frequency intervention time regulation **DELAY MAX** from 0.1 to 30 s.
- ✓ Minimum frequency intervention threshold regulation with rotary switch from 0.5 to 10 Hz.
- ✓ Minimum frequency intervention time regulation **DELAY MIN** from 0.1 to 30 s.
- ✓ Power supply from the measurement circuit.
- ✓ Automatic canceling when the frequency goes back inside the fixed limits.
- ✓ Normally energized state of the relays, de-energized at the intervention.
- ✓ Led indicating the presence of power supply.
- ✓ Led **MAX** indicating the maximum frequency intervention. ✓ Led **MIN** indicating the minimum frequency intervention.

REGULATIONS

Suppose and adjust the device with the following project data:

- ✓ nominal frequency of the line (**FREQ.**) = 50 Hz
- ✓ maximum frequency threshold (**MAX**) = 2 Hz
- ✓ maximum frequency intervention delay (**DELAY MAX**) = 5 s
- ✓ minimum frequency threshold (**MIN**) = 2 Hz
- ✓ minimum frequency intervention delay (**DELAY MIN**) = 5 s.

PROCEDURE:

1. Activate the prime mover and adjust the synchronous generator to the frequency and nominal voltage to provide the relay with the power supply voltage of 230 V (nominal voltage). In this condition the frequency relay is properly powered and shows no alarm.
2. Connect the multimeter set to Ohm alternatively to the NC contacts of the max/min frequency outputs relays and check the correspondence of the contacts (they correspond to the diagram shown on the panel in ordinary conditions, frequency in the limits).

3. Note: the frequency variations with the RPM potentiometer must be followed by the voltage regulation with the variator Uexc.
4. Increase the test frequency to about 53 Hz, record the time between the “overfrequency” and the same output relay tripping one (signaled by the interruption of continuity in the multimeter). If the intervention delay is not that supposed, adjust using the related device.
5. Take back the frequency to nominal value (50 V) and check the alarm cancels (the maximum frequency output relay cancels).
6. Drop the test frequency to about 47 Hz, record the time between the “underfrequency” and the same output relay tripping one (signaled by the interruption of continuity in the multimeter). If the intervention delay is not the one supposed, adjust with the related device
7. Take back the voltage to nominal value (50 V) and check the alarm cancels (the minimum frequency output relay cancels).
8. Repeat the intervention tests for max/min frequency with other threshold values.
9. The “over frequency” or “under frequency“ is signaled in the device front panel by the flashing of the MAX or MIN LEDs. The output relays tripping, at the end of the given delays, is signaled by the switching off of the respective LEDs. The canceling is automatic when the frequency returns to the fixed value.

The max/min voltage relay frequency, via clean contacts on its inner relays (NC contacts), can be included in the safeties to enable and keep the parallel of the generator with the public power mains or with another generator.

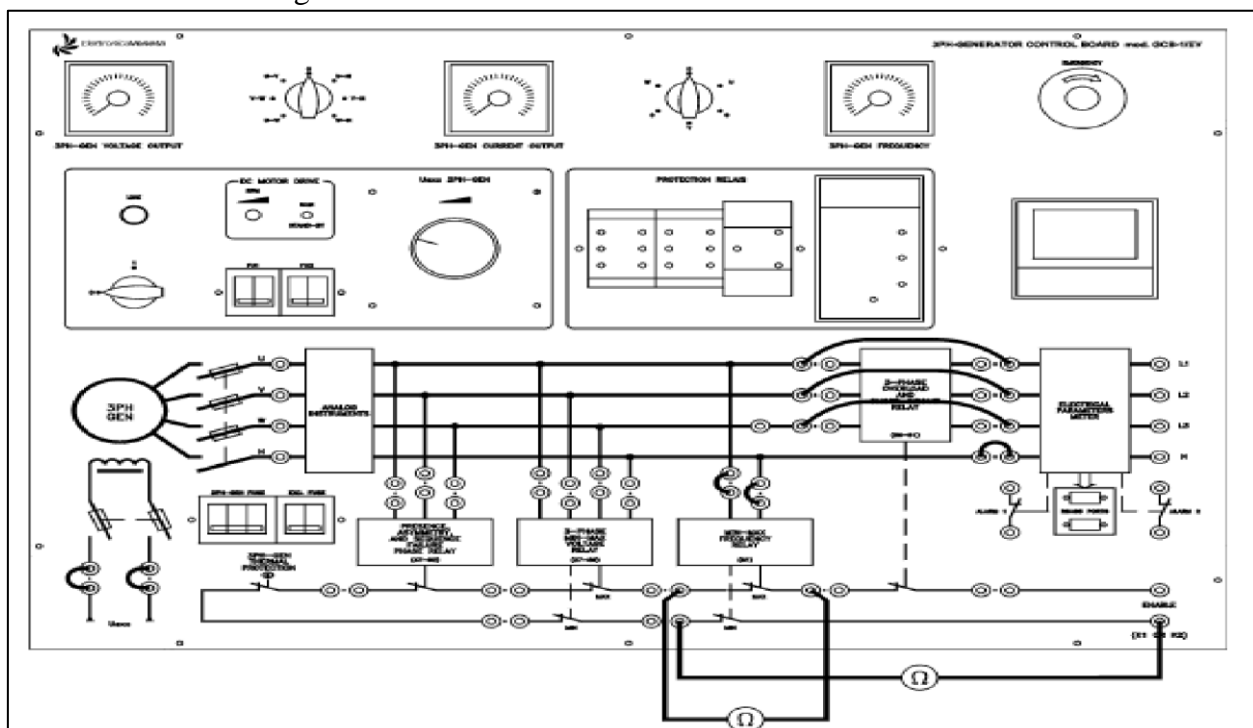

*Connections on the board GCB-1/EV.
Figure 2 Operation test of the max/min frequency relay.*



Course Code and Title: _____

Laboratory Session: No. _____ Date: _____

Psychomotor Domain Assessment Rubric-Level P3					
Skill Sets	Extent of Achievement				
	0	1	2	3	4
Equipment Identification Sensory skill to identify equipment and/or its component for a lab work. 10%	Not able to identify the equipment. 0	--	--	--	Able to identify equipment as well as its components. 40
Equipment Use Sensory skills to describe the use of the equipment for the lab work. 15%	Never describes the use of equipment. 0	Rarely able to describe the use of equipment. 15	Occasionally describe the use of equipment. 30	Often able to describe the use of equipment. 45	Frequently able to describe the use of equipment. 60
Procedural Skills Displays skills to act upon sequence of steps in lab work. 15%	Not able to either learn or perform lab work procedure. 0	Able to slightly understand lab work procedure and perform lab work. 15	Able to somewhat understand lab work procedure and perform lab work. 30	Able to moderately understand lab work procedure and perform lab work. 45	Able to fully understand lab work procedure and perform lab work. 60
Response Ability to imitate the lab work on his/her own. 15%	Not able to imitate the lab work. 0	Able to slightly imitate the lab work. 15	Able to somewhat imitate the lab work. 30	Able to moderately imitate the lab work. 45	Able to fully imitate the lab work. 60
Observation's Use Displays skills to perform related mathematical calculations using the observations from lab work. 15%	Not able to use lab work observations into mathematical calculations. 0	Able to slightly use lab work observations into mathematical calculations. 15	Able to somewhat use lab work observations into mathematical calculations. 30	Able to moderately use lab work observations into mathematical calculations. 45	Able to fully use lab work observations into mathematical calculations. 60
Safety Adherence Adherence to safety procedures. 10%	Doesn't adhere to safety procedures. 0	Slightly adheres to safety procedures. 10	Somewhat adheres to safety procedures. 20	Moderately adheres to safety procedures. 30	Fully adheres to safety procedures. 40
Equipment Handling Equipment care during the use. 10%	Doesn't handle equipment with required care. 0	Rarely handles equipment with required care. 10	Occasionally handles equipment with required care. 20	Often handles equipment with required care. 30	Handles equipment with required care. 40
Group Work Contributes in a group-based lab work. 10%	Never participates. 0	Rarely participates. 10	Occasionally participates and contributes. 20	Often participates and contributes. 30	Frequently participates and contributes. 40
Total Points (Out of 400)					
Weighted CLO (Psychomotor Score)		(Points /4)			
Remarks					
Instructor's Signature with Date:					

LAB SESSION 05

To check the working and functions of overload and short circuit relay.

Students are required to operate and set the overload and short circuit relay for different operating scenarios of loading conditions. Also to observe the effect of varying the pickup value and time of operation of relay.



Course Code and Title: _____

Laboratory Session: No. _____ Date: _____

Psychomotor Domain Assessment Rubric-Level P3					
Skill Sets	Extent of Achievement				
	0	1	2	3	4
Equipment Identification Sensory skill to identify equipment and/or its component for a lab work. 10%	Not able to identify the equipment. 0	--	--	--	Able to identify equipment as well as its components. 40
Equipment Use Sensory skills to describe the use of the equipment for the lab work. 15%	Never describes the use of equipment. 0	Rarely able to describe the use of equipment. 15	Occasionally describe the use of equipment. 30	Often able to describe the use of equipment. 45	Frequently able to describe the use of equipment. 60
Procedural Skills Displays skills to act upon sequence of steps in lab work. 15%	Not able to either learn or perform lab work procedure. 0	Able to slightly understand lab work procedure and perform lab work. 15	Able to somewhat understand lab work procedure and perform lab work. 30	Able to moderately understand lab work procedure and perform lab work. 45	Able to fully understand lab work procedure and perform lab work. 60
Response Ability to imitate the lab work on his/her own. 15%	Not able to imitate the lab work. 0	Able to slightly imitate the lab work. 15	Able to somewhat imitate the lab work. 30	Able to moderately imitate the lab work. 45	Able to fully imitate the lab work. 60
Observation's Use Displays skills to perform related mathematical calculations using the observations from lab work. 15%	Not able to use lab work observations into mathematical calculations. 0	Able to slightly use lab work observations into mathematical calculations. 15	Able to somewhat use lab work observations into mathematical calculations. 30	Able to moderately use lab work observations into mathematical calculations. 45	Able to fully use lab work observations into mathematical calculations. 60
Safety Adherence Adherence to safety procedures. 10%	Doesn't adhere to safety procedures. 0	Slightly adheres to safety procedures. 10	Somewhat adheres to safety procedures. 20	Moderately adheres to safety procedures. 30	Fully adheres to safety procedures. 40
Equipment Handling Equipment care during the use. 10%	Doesn't handle equipment with required care. 0	Rarely handles equipment with required care. 10	Occasionally handles equipment with required care. 20	Often handles equipment with required care. 30	Handles equipment with required care. 40
Group Work Contributes in a group-based lab work. 10%	Never participates. 0	Rarely participates. 10	Occasionally participates and contributes. 20	Often participates and contributes. 30	Frequently participates and contributes. 40
Total Points (Out of 400)					
Weighted CLO (Psychomotor Score)		(Points /4)			
Remarks					
Instructor's Signature with Date:					

LAB SESSION 06

TITLE:

To check the working of Alarm relay

APPARTUS:

- Module SR8 Alarm relays with two contacts for optical and acoustic signaling.
- 24-Vdc fixed power supply source, $I_n \geq 1$ A.
- Multimeter for electrical continuity tests (Ohmmeter).

THEORY:

The auxiliary relays applied to control acoustic and/or optical signaling are called alarm relays. With one or more exchange contacts it is possible to control bells, sirens, fixed or flashing light signaling lamps to recall the attention of the local or remote controller of the plant.

To fulfill their purpose the alarm relays, connect to the output of the protection relay and reproduce the state of the last (normal or alarm condition).

If the alarm relay has a contact, or more exchange contacts, it can be used as inverting (not energized relay = active alarm or vice versa).

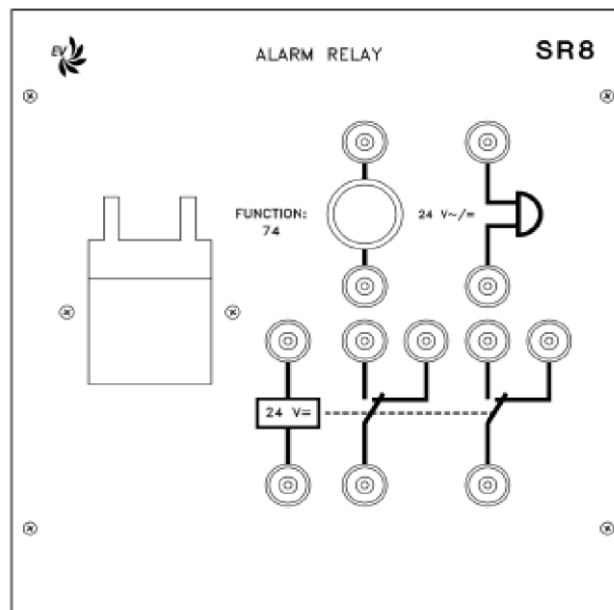

Figure 1: Alarm Relay

PROCEDURE:

OPERATIVE MODE Relay used to activate an alarm (negative safety).

1. Follow the electrical diagram of figure 2.
2. Set the module SR8 into the module-holder frame if available.
3. Connect the auxiliary voltage and simulate the closing of the NO contact of the maximum current relay.
4. Check the acoustic signal activation.

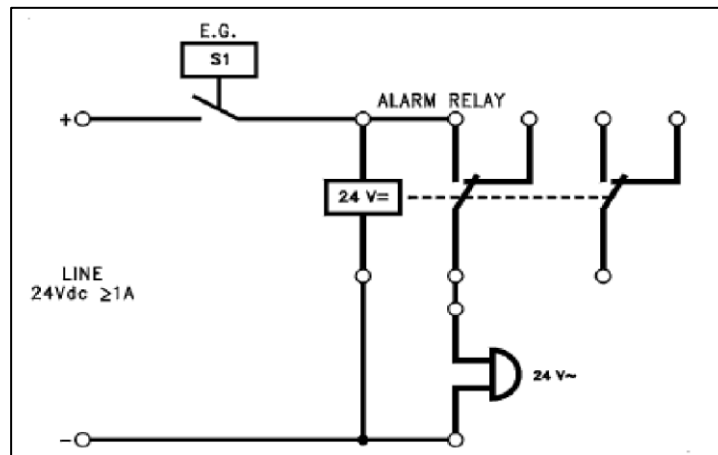

Figure 2 Usage diagram of an alarm relay connected to a protection relay with output on NO contact. It is negative safety because if the alarm relay breaks no signaling activates.

OPERATIVE MODE Relay used to activate different alarm signalers (positive safety).

1. Follow the electrical diagram of figure 3.
2. Set the module SR8 into the module-holder frame if available.
3. Connect the auxiliary voltage and simulate the closing of the NC contact of the maximum current relay.
4. Check the acoustic and optical signal activation.

With this circuit, when compared to the last, we want to focus the attention on the concept of “positive safety” and the possibility to control alarm signalers, belonging to alternated current or continuous current circuits and/or with different nominal voltages.

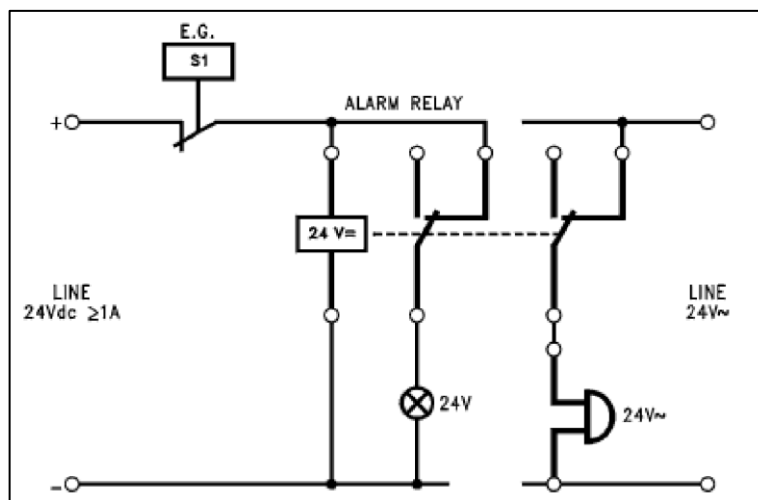

Figure 3: Usage diagram of an alarm relay connected to a protection relay with output on NC contact. It is positive safety as the fault on the circuit or the alarm relay causes the signaling activation. The fault, recalls the user's attention for maintenance.

LAB SESSION 07**TITLE:**

To check operation of Potential Transformer and calculate Error of Potential transformer

APPARTUS:

- Module SR12 Voltage or voltmetric transformers (VT).
- Variable three-phase power supply source 0 - 430 Vac.
- 2 voltmeters to measure the alternated voltage with 500-V range.
- 5000- Ω table-kind rheostat or equivalent to adjust the load current across the secondary of the VT.

THEORY:

The voltage transformers (VT) are used to match the alternated voltage values to the ranges of the voltmeters or voltmetric relays. They are characterized by a number of coils equal to the primary N_1 plus the number of coils of the secondary N_2 . In order to take the effective transformation ratio (**K**) very near the nominal transformation ratio (**K_n**), the inner voltage drop must be negligible, this occurs only if the transformer works in conditions next to no-load operation. In these conditions there is.

$$K_n \equiv K = U_1 / U_2 \equiv E_1 / E_2 = N_1 / N_2$$

To make the inner voltage drop negligible the resistance as well as the dispersion reactance of the two windings must be very small. The windings are carried out using very low current densities, much lower than those used for industrial transformers. The coupling between the primary and the secondary is cured to minimize the dispersed flows.

The percentage error ratio is defined by:

$$Fi\% = (K_n - K) / K \cdot 100 \text{ or } = (K_n \cdot U_2 - U_1) / U_1 \cdot 100$$

The error angle is the shift angle between U_1 and U_2 , considering a positive fact if the second is in lead on the first and negative vice versa. This error has no effect on the measurements of the single voltage, it affects, instead, the active power or power measurements for which it is necessary to read even the shift between current and voltage.

The nominal performance **S_n** [VA] is the maximum apparent power the VT can provide on the voltmetric equipments (all in parallel), it powers without overcoming the error limit of the class it belongs to. The performance is referred, by convention, to a power factor equal to 0.8 of delay. With the performance and the secondary nominal voltage, it is possible to determine the maximum admittance (or minimum impedance) that can be connected to the secondary of the VT, this in fact will be:

$$Y_{2\max} = 1 / Z_{2\min} = S_n / U_{2n}^2 [1/ \Omega]$$

The protections allowed to protect the primary and/or the secondary of a voltmetric transformer are those against short-circuits. Fuses are largely used.

PROCEDURE:

1. Follow the electrical diagram of figure 1.
2. Set the module SR12 into the module-holder frame if available.
3. Connect to the terminals 500 V L_1 and L_2 of the variable three-phase power supply source. Connect a voltmeter to measure the alternated voltage at the transformer input (voltage U_1 , primary). Connect the PE terminal to the protection conductor, too.
4. Connect the transformer 100-V output terminals to an RC load rheostat (for the resistor value see table 5.12.1). For safety reasons, connect a point of the secondary to ground. In the exercise no protection device is used on the secondary of the VT so: **Attention** never make the VT operate in short-circuit or with a load higher than its nominal power, the VT could damage.
5. Connect a voltmeter to measure the alternated voltage at the transformer output (voltage U_2 , secondary). The two voltmeters employed respectively in the primary and the secondary, must have the same accuracy class and this must be at least an order lower than the one of the VT (more accurate of the VT to be checked).
6. Eventually connect a milliammeter in series to the load on the secondary winding to prevent the I_2 max to be overcome.
7. Connect the variable power supply, adjust to about the 80 % of the transformer nominal voltage; adjust the rheostat R_2 to obtain about 50 % of the nominal current in the secondary (see table 1 for the calculation).
8. Record the values of the voltages U_1 and U_2 in the table 1.
9. Apply the formula for calculation of the percentage ratio error (reported in the table) and fill the table.

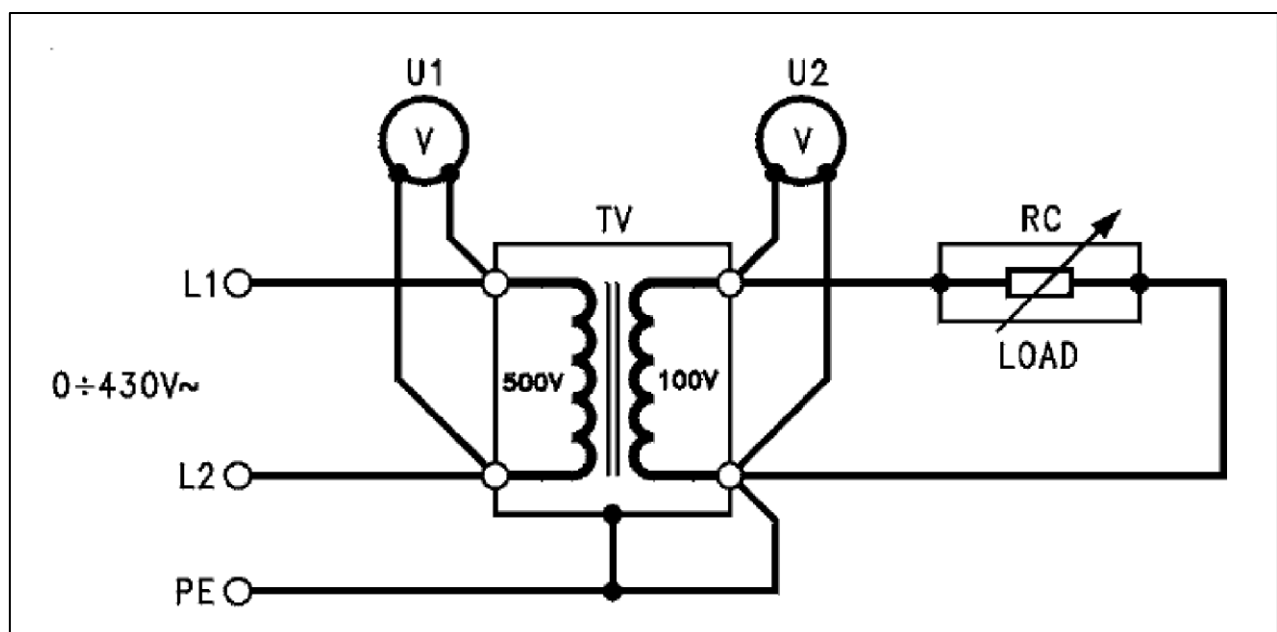

Figure 1 Electrical connection diagram of a VT for the performance test

Table 1 Checking the error of VT ratio mod

$S_n = 10 \text{ VA}$, Class = 0.5, $U_{1n} = 500 \text{ V}$, $U_{2n} = 100 \text{ V}$, $f = 50 \text{ Hz}$, $K_n = 5 \%$

Performance / class	U_1 (V)	U_2 (V)	K effective	Z min. (Ω)	Error %
No-load secondary	100			inf	
	200			inf	
	300			inf	
	400			inf	
	500			inf	
10 VA / 0.5 %	100			1000	
	200				
	300				
	400				
	500				
20 VA / 1 %	100			500	
	200				
	300				
	400				
	500				
<p>Z minimum = U_{2n}^2 / S_n (Ω); $I_{2max.} = S_n / U_2$ (A); K effective = U_1 / U_2 Ratio error % = $(K_n - K) / K \cdot 100$ or = $(K_n \cdot U_2 - U_1) / U_1 \cdot 100$</p>					
<p>Z minimum for $S_n = 10 \text{ VA} = 100^2 / 10 = 1000\Omega$;</p> <p>Z minimum for $S_n = 20 \text{ VA} = 100^2 / 20 = 500 \Omega$</p>					

LAB SESSION 08**Line Synchronization (Generator & KE Supply)****Objective**

To perform synchronization of two different lines.

Reference

Section 1.4.8.3 (synchronizing instruments).

Test object and position

PST2210 Generator Station or PST2270 Additional Generator Station.

Recommended external equipment

None.

Introduction

When connecting two lines in the system, three conditions must be fulfilled. The voltage in both lines must have the same amplitude, phase and frequency, see figure below. It is absolutely necessary that the lines are in phase and have the same amplitude. The reason is that any difference in these parameters will result in a current being forced through the system, only limited by the internal impedance in each voltage source.

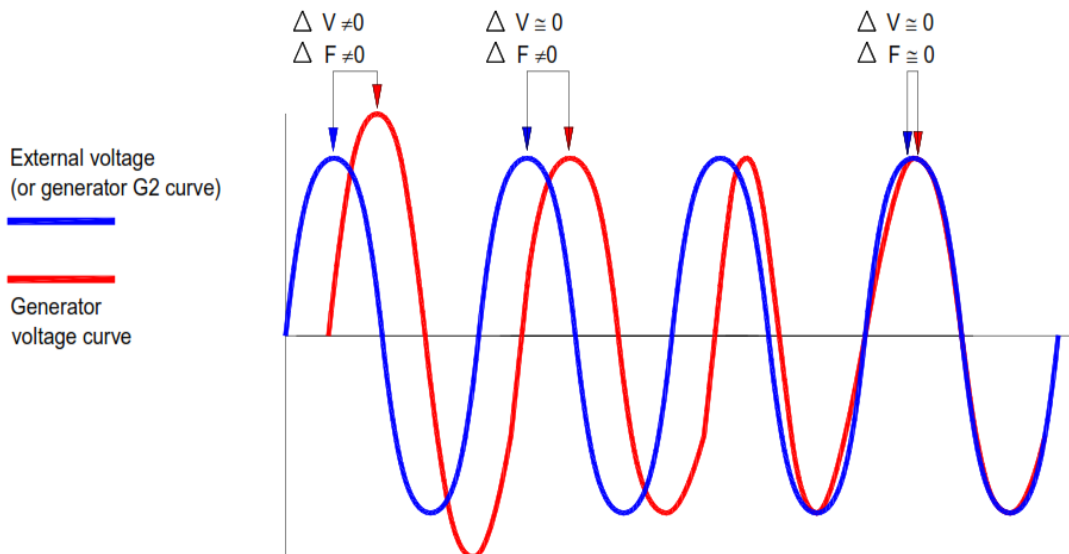

The **PST2210/2270 Synchronizing Gear Panel** (C2K5) includes the following equipment (referring to the numbers marked in the plate beneath):

- 1.** Voltmeters for HV A-B Busbar, each with switch for selection of measurement between: L1-L2, L2-L3, L1-L3, L1-N, L2-N or L3-N. The instruments are used to control voltage amplitude and symmetry in the buses before paralleling (or synchronizing).
- 2. Bargraphs** for monitoring of voltage (350-450VAC) and frequency (45-55Hz or 55-65Hz) on respective busbar. Numerical LED's combined with graphical bars are helpful in procedures of synchronizing nets together.
- 3. Synchroscope** for: - supervision of differences in phase angle (ϕ), frequency (Δf) and voltage (ΔV).
- signaling of allowed synchronization.

Synchronizing lamps are connected for rotating phasing. The three lamps must blink sequentially (rotating) before phasing is allowed. If pulsating, phasing may not be allowed because of wrong phase order.

Phase point selector switch is used to choose the synchronization point. The user can choose between: CB1, CB2, CB3 or CB4. The synchronization instruments are then connected to measure the values on both sides of the selected circuit breaker.

Autosynch switch: For automatic synchronizing over chosen CB. Useful when synchronizing is performed over remotely placed CBs. Automatic synchronizing is started when chosen CB and the AUTOSYNCH switch both are in ON position. Synchronizing is then automatically performed when the synchroscope is signaling allowed synchronization.

4. Switchgear: Isolators (**I3, I4**) and circuit breaker (**CB2**) for connecting A-HV and B-HV Busbars.

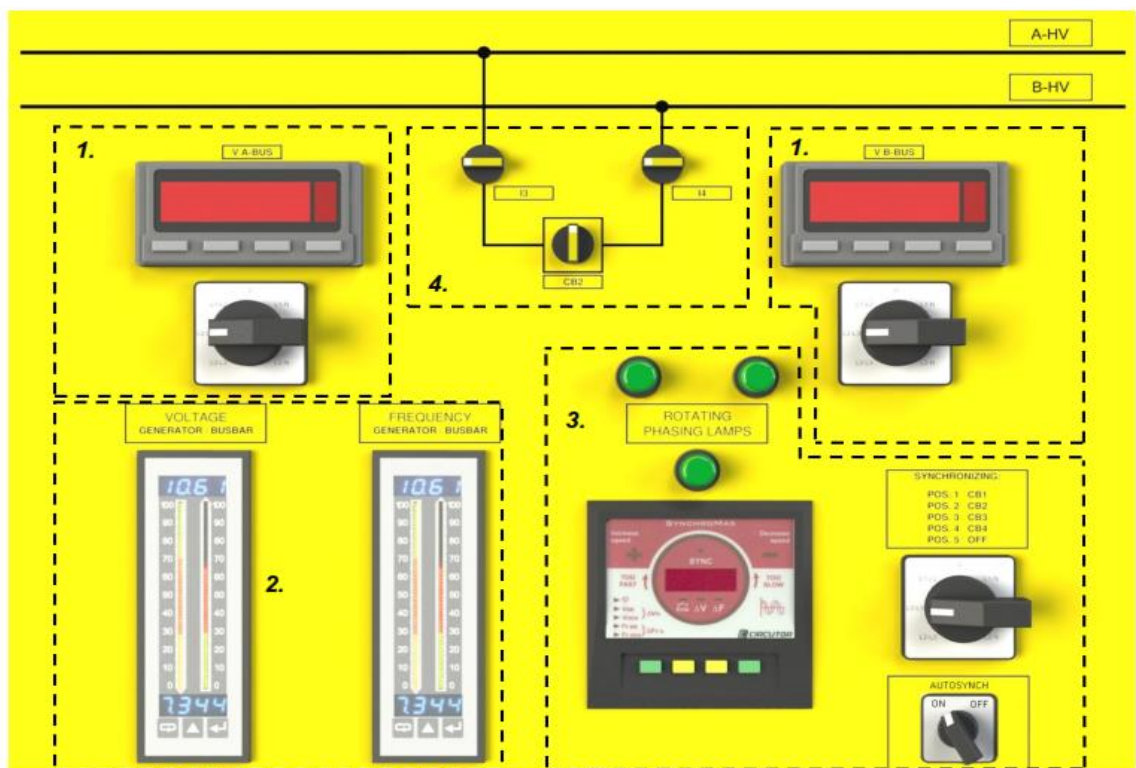

Procedure

1. Make connections in PST2210/2270 Cubicle 1 according to section 2.1.3.1.
2. Put the system in stand-by mode according to experiment 4.1.
3. Check that **all isolators and circuit breakers are opened** (OFF position).
4. On the PST2210/2270 Power Grid Panel (C2J25) connect the grid to the A-HV Busbar by closing **CB GRID** and **CB A-HV**.

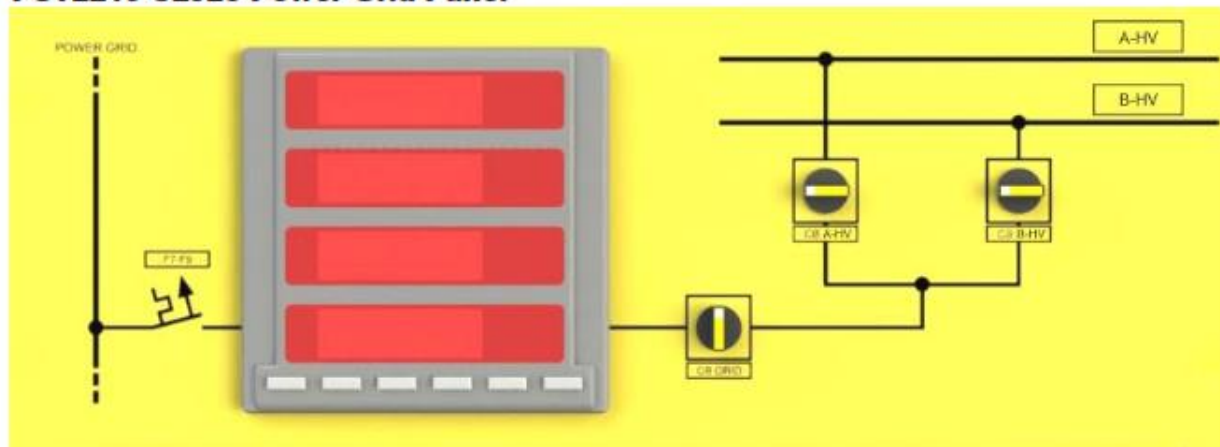
PST2210 C2J25 Power Grid Panel

When synchronizing, the Power Grid should be connected to the A-Busbar, and the generator to be synchronized to the grid, should be connected to the B-Busbar. The reason is that the synchroscope by default is configured with the condition that the B-Busbar (Generator to be synchronized) should have a frequency equal to or slightly higher (+0.3Hz) than the A-Busbar (Power Grid). The reason that the generator to be synchronized should have a slightly higher frequency is to avoid the generator from being subject to reverse power.

5. In PST2210/2270 Cubicle 1, run the generator at 1500rpm (or 1800rpm for 60Hz) as in experiment 4.5.

Note! Both the turbine speed- and the generator field magnetizing voltage control shall be in MANUAL mode.

6. In PST2210/2270 Cubicle 1, magnetize the generator until the generator voltage, U_g , reaches 220 to 230 V, see experiment 4.6.

7. In PST2210/2270 Cubicle 1, close I2 and then CB1, to energize the B-Busbar with approximately 3x400V.

8. In PST2210/2270 Cubicle 2, choose CB2 as synchronization point by means of the **PHASE POINT SELECTOR SWITCH**.

9. In PST2210/2270 Cubicle 2, close Isolators I3 and I4. The left side of CB2 is now energized with the voltage from the Power Grid and the right side is energized with the voltage from the generator.

Now the following should be seen before continuing with the synchronization procedure:

- The Bargraph voltmeters are indicating the Generator voltage and the Power Grid voltage (the Power Grid may also be constituted by an additional generator)
- The Bargraph frequency meters are indicating the corresponding frequencies.
- The Synchroscope LEDs are rotating clockwise or ccw.
- The ROTATING PHASING LAMPS are blinking sequentially (“rotating”).

WARNING! If the ROTATING PHASING LAMPS are blinking at the same time instead of rotating, the phase sequence is incorrect. In such case two connections of either the generator or the power grid must be switched in order to make the phase lamps rotate!

Synchronization procedure continued:

1. In PST2210/2270 Cubicle 1, adjust the generator voltage until both bargraphs for voltage are in parallel levels.
 2. In PST2210/2270 Cubicle 1, adjust the turbine speed until the frequency reaches 50Hz (or 60Hz in a 60Hz system) and both bargraphs for frequency are in parallel levels.
 3. In PST2210/2270 Cubicle 2, find the phasing point by means of the synchroscope: the top LED should light up and the two warning LEDs in the lower middle of the instrument should be off.
 4. In PST2210/2270 Cubicle 2, when the top LED of the synchroscope lights up and the two warning LEDs in the lower middle are off, quickly turn CB2 to position ON and the two lines are synchronized together.
 5. In PST2210/2270 Cubicle 1, try to increase the turbine speed: active power will be indicated.
 6. In PST2210/2270 Cubicle 1, try to increase the generator voltage: reactive power will be indicated.
 7. In PST2210/2270 Cubicle 1, turn off the DC-motor (Turbine) by switching CBM into off position: the synchronous machine is now operating as a motor.
-



Course Code and Title: _____

Laboratory Session: No. _____ Date: _____

Psychomotor Domain Assessment Rubric-Level P3					
Skill Sets	Extent of Achievement				
	0	1	2	3	4
Equipment Identification Sensory skill to identify equipment and/or its component for a lab work. 10%	Not able to identify the equipment. 0	--	--	--	Able to identify equipment as well as its components. 40
Equipment Use Sensory skills to describe the use of the equipment for the lab work. 15%	Never describes the use of equipment. 0	Rarely able to describe the use of equipment. 15	Occasionally describe the use of equipment. 30	Often able to describe the use of equipment. 45	Frequently able to describe the use of equipment. 60
Procedural Skills Displays skills to act upon sequence of steps in lab work. 15%	Not able to either learn or perform lab work procedure. 0	Able to slightly understand lab work procedure and perform lab work. 15	Able to somewhat understand lab work procedure and perform lab work. 30	Able to moderately understand lab work procedure and perform lab work. 45	Able to fully understand lab work procedure and perform lab work. 60
Response Ability to imitate the lab work on his/her own. 15%	Not able to imitate the lab work. 0	Able to slightly imitate the lab work. 15	Able to somewhat imitate the lab work. 30	Able to moderately imitate the lab work. 45	Able to fully imitate the lab work. 60
Observation's Use Displays skills to perform related mathematical calculations using the observations from lab work. 15%	Not able to use lab work observations into mathematical calculations. 0	Able to slightly use lab work observations into mathematical calculations. 15	Able to somewhat use lab work observations into mathematical calculations. 30	Able to moderately use lab work observations into mathematical calculations. 45	Able to fully use lab work observations into mathematical calculations. 60
Safety Adherence Adherence to safety procedures. 10%	Doesn't adhere to safety procedures. 0	Slightly adheres to safety procedures. 10	Somewhat adheres to safety procedures. 20	Moderately adheres to safety procedures. 30	Fully adheres to safety procedures. 40
Equipment Handling Equipment care during the use. 10%	Doesn't handle equipment with required care. 0	Rarely handles equipment with required care. 10	Occasionally handles equipment with required care 20	Often handles equipment with required care. 30	Handles equipment with required care. 40
Group Work Contributes in a group-based lab work. 10%	Never participates. 0	Rarely participates. 10	Occasionally participates and contributes. 20	Often participates and contributes. 30	Frequently participates and contributes. 40
Total Points (Out of 400)					
Weighted CLO (Psychomotor Score)		(Points /4)			
Remarks					
Instructor's Signature with Date:					

LAB SESSION 09

RET 630 (Voltage & Frequency Protection)

Frequency (DAPTOF)

The over frequency protection function (DAPTOF) can be used to protect network components from possible damage caused by over frequency conditions. The frequency must exceed the set start frequency value before the function can start and operate. DAPTOF operates with definite time (DT) characteristics. The frequency measurement is based on the voltage available only for preprocessor function SMAI internally. This voltage is dependent on all connected phase-to-earth or phase-to-phase voltages. If only one phase-to-earth or phase-to-phase voltage is connected then, that is used.

DAPTOF is applicable in all situations where high levels of the fundamental frequency of power system voltage must be reliably detected. A high fundamental frequency in a power system indicates that there is an unbalance between production and consumption. In this case, the available generation is too large compared to the power demanded by the load connected to the power grid. This can occur due to a sudden loss of a significant amount of load or due to failures in the turbine governor system. If the situation continues and escalates, the power system loses its stability. The over frequency function is suitable for signaling in such situations. The over frequency function is very sensitive and accurate and can also be used to alert operators that frequency has slightly deviated from the set-point and that manual actions can suffice.

RET630 - T1 Protection (C2) - Parameter Setting					
Group / Parameter Name	IED Value	PC Value	Unit	Min	Max
✓ DAPTOF: 1					
✓ Operation		Off			
✓ Reset delay time		0,100	s	0,000	60,000
✓ Setting Group1		<input checked="" type="checkbox"/>			
✓ Start value		56,0	Hz	35,0	64,0
✓ Operate delay time		10,000	s	0,170	60,000

Fig. DAPTOF

The parameters of the function is:

Operation Enables/disables the function (on/off).

Reset delay time Defines the time until the **Start** of a trip is automatically reset if the fault suddenly disappears (value drops below the **Start value**) before the **Operate delay time** is exceeded.

Start value Start value in Hz.

Operate delay time Defines the delay time until the operation of the function is performed (tripped).

For extensive descriptions of all the different parameters in the over frequency protection study the ABB RET630 Technical Manual section 4.

Frequency (DAPTUF)

The under frequency protection function (DAPTUF) can be used to protect network components from possible damage caused by underfrequency conditions. The frequency must fall below the set start frequency value before the function can start and operate. DAPTUF operates with definite time (DT) characteristics. The frequency measurement is based on the voltage available only for preprocessor function SMAI internally. This voltage is dependent on all connected phase-to-earth or phase-to-phase voltages. If only one phase-to-earth or phase-to-phase voltage is connected then, that is used.

DAPTUF is applicable in all situations where a reliable detection of a low fundamental power system voltage frequency is needed. A low fundamental frequency in a power system indicates that the power generated is too low to meet the power demanded by the load connected to the power grid. An underfrequency can occur as a result of an overload of the generators operating in an isolated system. It can also occur as a result of a serious fault in the power system due to the deficit of generation when compared to the load. This can happen due to a fault in the grid system on transmission lines that link two parts of the system. As a result, the system splits in two with one part having the excess load and the other part the corresponding deficit. The frequency dips rapidly in the latter, resulting in load shedding either by the load shedding relays or by the operator action. DAPTUF detects such situations and provides signaling suitable for load shedding, generator boosting and so on. In some cases, to reduce the power system voltage and the voltage dependent part of the load, shunt reactors are automatically switched on at low frequencies. The DAPTUF function is very sensitive and accurate and can also be used to alert the operators that the frequency deviates slightly from the set-point and that manual actions can be sufficient enough to ensure the stability of the system. The underfrequency signaling is also used for over excitation detection. This is especially important for generator step-up transformers during a rollout sequence when the transformers can be connected to the generator but disconnected from the grid. If the generator is still energized, the system experiences over-excitation due to the low frequency.

RET630 - T1 Protection (C2) - Parameter Setting					
Group / Parameter Name	IED Value	PC Value	Unit	Min	Max
✓ DAPTUF: 1					
✓ Operation		Off			
✓ Reset delay time		0,100	s	0,000	60,000
✓ Setting Group1		<input checked="" type="checkbox"/>			
✓ Start value		48,8	Hz	35,0	64,0
✓ Restore start Val		49,9	Hz	35,0	64,0
✓ Operate delay time		0,200	s	0,170	60,000
✓ Restore delay time		0,100	s	0,000	60,000

Fig. DAPTUF

The parameters of the function is:

Operation Enables/disables the function (on/off).

Reset delay time Defines the time until the **Start** of a trip is automatically reset if the fault suddenly disappears (value drops below the **Start**

value) before the **Operate delay time** is exceeded.

Start value Start value in Hz.

Restore start Val Restore start value in Hz.

Operate delay time Defines the delay time until the operation of the function is performed (tripped).

Restore delay time Defines the delay time until the function restores the trip signal.

For extensive descriptions of all the different parameters in the under-frequency protection study the ABB RET630 Technical Manual section 4.

Frequency (DAPFRC)

The frequency gradient protection (DAPFRC) is used to detect the increase or decrease of the fundamental power system voltage frequency at an early stage. By means of an early indication of disturbance in the system, remedial actions can be taken such as generation- or load shedding.

The rate of change of the fundamental frequency is calculated and compared to the set frequency gradient value (Start value) before the function can start and operate. DAPFRC operates with the definite time (DT) characteristics.

RET630 - T1 Protection (C2) - Parameter Setting					
Group / Parameter Name	IED Value	PC Value	Unit	Min	Max
✓ DAPFRC: 1					
✓ Operation		Off			
✓ Reset delay time		0,100	s	0,000	60,000
✓ Setting Group1					
✓ Start value		7,00	Hz/s	-10,00	10,00
✓ Operation delay time		5,000	s	0,120	60,000

Fig. 5.34 DAPFRC

The parameters of the function are:

Operation Enables/disables the function (on/off).

Reset delay time Defines the time until the **Start** of a trip is automatically reset if the fault suddenly disappears (value drops below the **Start value**) before the **Operate delay time** is exceeded.

Start value Start value in Hz/s.

Operate delay time Defines the delay time until the operation of the function is performed (tripped).

For extensive descriptions of all the different parameters in the frequency gradient protection study the ABB RET630 Technical Manual section 4.

Voltage (PHPTOV)

The three-phase overvoltage protection PHPTOV1/2 (instance 1/2) is applied on power system elements, such as generators, transformers, motors and power lines, to protect the system from excessive voltages that could damage the insulation and cause insulation breakdown. PHPTOV includes both definite time (DT) and inverse definite minimum time (IDMT) characteristics for the delay of the trip.

Overvoltage in a network occurs either due to the transient surges on the network or due to prolonged non-transient coarses for example defective voltage regulators or loss of load. Surge arresters are used to protect the network against the transient over voltages, but the IED protection function is used to protect against the non-transient over voltages. The prolonged non-transient overvoltage may occur in the network due to contingencies such as:

- Defective operation of the automatic voltage regulator when the generator is in isolated operation.
- Operation under manual control with the voltage regulator out of service. A sudden variation of load, in particular the reactive power component, gives rise to a substantial change in voltage because of the large voltage regulation inherent in a typical alternator.
- Sudden loss of load due to the tripping of outgoing feeders, leaving the generator isolated or feeding a very small load, can cause a sudden rise in the terminal voltage due to the trapped field flux and overspeed.

PHPTOV is not usually applied to the attended generators (if so, mainly for indication such as in the PST) but can be required for the unattended automatic hydro-stations. If a load sensitive to over voltages remains connected, it leads to equipment damage. Therefore, it is essential to provide protection against the non-transient overvoltage in the form of time delayed element, either IDMT or DT.

RET630 - T1 Protection (C2) - Parameter Setting					
Group / Parameter Name	IED Value	PC Value	Unit	Min	Max
✓ PHPTOV: 1					
✓ Operation		Off			
✓ Base value Sel phase		Phase Grp 1			
✓ Voltage selection		phase-to-earth			
✓ Num of start phases		1 out of 3			
✓ Relative hysteresis		4,0	%	1,0	5,0
✓ Setting Group1			<input checked="" type="checkbox"/>		
✓ Start value		1,05	pu	0,05	1,60
✓ Time multiplier		1,00		0,05	15,00
✓ Operating curve type		IEC Def. Time			
✓ Type of reset curve		Immediate			
✓ Type of time reset		Freeze Op timer			
✓ Operate delay time		0,040	s	0,040	300,000

Fig. PHPTOV1/2

Definite time characteristics (**Operating curve type = IEC Def. Time**) is recommended for a straight forward basic functionality. The most essential parameters are then (keep other parameters default):

Operation Enables/disables the function (on/off).

Base value Sel phase Selection of predefined Base values (see section 5.5.3). For protective functions connected to **winding 1, Phase Grp 1** should be selected, and for protective functions connected to **winding 2, Phase Grp 2** is to be selected.

Base values are the reference values which the protective functions refers to when protective levels are configured. In the PST, different Base values have been configured/selected, according to the nominal values of the different parts of the system. The appropriate base values (in which we here simply select among) suitable for the protective functions connected on different sides of the protected objects, are described in section section 5.5.3.

Voltage selection The Voltage selection setting is used for selecting phase-to-earth Or phase-to-phase voltages for protection.

The connection type in the PST is **phase-to-earth**.

Num of start phases Defines the required number of phases (1, 2 or 3 out of 3) exceeding the **Start value** before the start and operation of the function is performed (tripped). The PST has only one phase connected for measuring of overvoltage. The required Num of start phases should therefore be set to **1 out of 3**.

Relative hysteresis Relative Hysteresis to compensate for oscillations. The Relative hysteresis setting can be used for preventing unnecessary oscillations if the input signal slightly varies above/below the Start value setting.

Reset delay time Defines the time until the **Start** of a trip is automatically reset if the fault suddenly disappears (value drops below the **Start value**) before the **Operate delay time** is exceeded.

Start value Start value referring to the nominal primary value. The nominal primary value depends on the selection of parameter **Base value Sel phase** which in turn is defined according to Table 29, section 5.5.3.

Operate delay time Defines the delay time until the operation of the function is performed (tripped).

For extensive descriptions of all the different parameters in the three-phase overvoltage protection study the ABB RET630 Technical Manual section 4.

Voltage (PHPTUV)

The three-phase undervoltage protection PHPTUV1/2 (instance 1/2) is applied to power system elements, such as generators, transformers, motors and power lines, to detect low voltage conditions. PHPTUV includes both definite time (DT) and inverse definite minimum time (IDMT) characteristics for the delay of the trip.

Low voltage conditions are caused by abnormal operation or a fault in the power system. PHPTUV can be used in combination with overcurrent protections. PHPTUV can also be

used to initiate voltage correction measures, such as insertion of shunt capacitor banks, to compensate for a reactive load and thereby to increase the voltage.

Low voltage conditions can be caused by:

- Malfunctioning of a voltage regulator or wrong settings under manual control (symmetrical voltage decrease).
 - Overload (symmetrical voltage decrease).
 - Short circuits, often as phase-to-earth faults (unsymmetrical voltage decrease).
- PHPTUV prevents sensitive equipment from running under conditions that could cause overheating and thus shorten their life time expectancy. In many cases, PHPTUV is a useful function in circuits for local or remote automation processes in the power system.

RET630 - T1 Protection (C2) - Parameter Setting					
Group / Parameter Name	IED Value	PC Value	Unit	Min	Max
✓ PHPTUV: 1					
✓ Operation		Off			
✓ Base value Sel phase		Phase Grp 1			
✓ Voltage selection		phase-to-earth			
✓ Phase supervision		A or AB			
✓ Num of start phases		1 out of 3			
✓ Voltage block value		0,20	pu	0,05	1,00
✓ Relative hysteresis		4,0	%	1,0	5,0
✓ Setting Group1			<input checked="" type="checkbox"/>		
✓ Start value		0,90	pu	0,05	1,20
✓ Time multiplier		1,00		0,05	15,00
✓ Operating curve type		IEC Def. Time			
✓ Type of reset curve		Immediate			
✓ Type of time reset		Freeze Op timer			
✓ Operate delay time		0,040	s	0,040	300,000

Fig. PHPTUV1/2

Definite time characteristics (**Operating curve type = IEC Def. Time**) is recommended for a

straight forward basic functionality. The most essential parameters are then (keep other parameters default):

Operation Enables/disables the function (on/off).

Base value Sel phase Selection of predefined Base values (see section 5.5.3). For protective functions connected to **winding 1, Phase Grp 1** should be selected, and for protective functions connected to **winding 2, Phase Grp 2** is to be selected.

Base values are the reference values which the protective functions refers to when protective levels are configured. In the PST, different Base values have been configured/selected, according to the nominal values of the different parts of the system. The appropriate base

values (in which we here simply select among) suitable for the protective functions connected on different sides of the protected objects, are described in section 5.5.3.

Voltage selection The Voltage selection setting is used for selecting phase-to-earth Or phase-to-phase voltages for protection.

The connection type in the PST is **phase-to-earth**.

Phase supervision Parameter for phase selection. In the PST voltage measurement is performed between phase L1 and earth which corresponds to the parameter selection **A or AB** (A=L1, B=L2, C=L3). If the parameter were to be selected as for instance All, the protective function would immediately trip undervoltage because the measured voltage is zero = not measured on phase L2 and phase L3.

Voltage block value Low level blocking for undervoltage mode. Can be used to block the function from tripping under a certain voltage level where the function is not to be in active mode.

Relative hysteresis Relative Hysteresis to compensate for oscillations. The Relative hysteresis setting can be used for preventing unnecessary oscillations if the input signal slightly varies above/below the Start value setting.

Num of start phases Defines the required number of phases (1, 2 or 3 out of 3) exceeding the **Start value** before the start and operation of the function is performed (tripped). The PST has only one phase connected for measuring of overvoltage. The required Num of start phases should therefore be set to **1 out of 3**.

Start value Start value referring to the nominal primary value. The nominal primary value depends on the selection of parameter **Base value Sel phase** which in turn is defined according to Table 29, section 5.5.3.

Operate delay time Defines the delay time until the operation of the function is performed (tripped).

For extensive descriptions of all the different parameters in the three-phase undervoltage protection study the ABB RET630 Technical Manual section 4.

Voltage (ROVPTOV)

The residual overvoltage protection ROVPTOV is used in distribution networks where the residual overvoltage can reach non-acceptable levels, for example, in isolated neutral, resistance earthed or reactance earthed systems. The function starts when the residual voltage exceeds the set limit (Start value). ROVPTOV operates with the definite time (DT) characteristic.

In isolated neutral, resistance earthed or reactance earthed systems, the system neutral voltage, that is, the residual voltage, increases in case of any fault connected to earth. Depending on the type of the fault and the fault resistance, the residual voltage reaches different values. The highest residual voltage, equal to the phase-earth voltage, is achieved for a single-phase earth fault.

In the PST, the residual voltage is measured by a single-phase voltage transformer, located between the transformer/generator starpoint and earth.

RET630 - T1 Protection (C2) - Parameter Setting					
Group / Parameter Name	IED Value	PC Value	Unit	Min	Max
✓ ROVPTOV: 1					
✓ Operation		On			
✓ Base value Sel Res		Residual Grp 1			
✓ Reset delay time		0,020	s	0,000	60,000
✓ Setting Group1			<input checked="" type="checkbox"/>		
✓ Start value		0,030	pu	0,010	1,000
✓ Operate delay time		0,040	s	0,040	300,000

Fig. ROVPTOV

The parameters of the function are:

Operation Enables/disables the function (on/off).

Base value Sel Res Selection of predefined Base values (see section 5.5.3). For protective functions connected to **winding 1, Residual Grp 1** should be selected, and for protective functions connected to **winding 2, Residual Grp 2** is to be selected.

Base values are the reference values which the protective functions refers to when protective levels are configured. In the PST, different Base values have been configured/selected, according to the nominal values of the different parts of the system. The appropriate base values (in which we here simply selects among) suitable for the protective functions connected on different sides of the protected objects, are described in section section 5.5.3.

Reset delay time Defines the time until the **Start** of a tripp is automatically reset if the fault suddenly disappears (value drops below the **Start value**) before the **Operate delay time** is exceeded.

Start value Start value referring to the nominal primary value. The nominal primary value depends on the selection of parameter **Base value Sel Res** which in turn is defined according to Table 29, section 5.5.3.

Operate delay time Defines the delay time until the operation of the function is performed (tripped).

For extensive descriptions of all the different parameters in the residual overvoltage protection study the ABB RET630 Technical Manual section 4.



Course Code and Title: _____

Laboratory Session: No. _____ Date: _____

Psychomotor Domain Assessment Rubric-Level P3					
Skill Sets	Extent of Achievement				
	0	1	2	3	4
Equipment Identification Sensory skill to identify equipment and/or its component for a lab work. 10%	Not able to identify the equipment. 0	--	--	--	Able to identify equipment as well as its components. 40
Equipment Use Sensory skills to describe the use of the equipment for the lab work. 15%	Never describes the use of equipment. 0	Rarely able to describe the use of equipment. 15	Occasionally describe the use of equipment. 30	Often able to describe the use of equipment. 45	Frequently able to describe the use of equipment. 60
Procedural Skills Displays skills to act upon sequence of steps in lab work. 15%	Not able to either learn or perform lab work procedure. 0	Able to slightly understand lab work procedure and perform lab work. 15	Able to somewhat understand lab work procedure and perform lab work. 30	Able to moderately understand lab work procedure and perform lab work. 45	Able to fully understand lab work procedure and perform lab work. 60
Response Ability to imitate the lab work on his/her own. 15%	Not able to imitate the lab work. 0	Able to slightly imitate the lab work. 15	Able to somewhat imitate the lab work. 30	Able to moderately imitate the lab work. 45	Able to fully imitate the lab work. 60
Observation's Use Displays skills to perform related mathematical calculations using the observations from lab work. 15%	Not able to use lab work observations into mathematical calculations. 0	Able to slightly use lab work observations into mathematical calculations. 15	Able to somewhat use lab work observations into mathematical calculations. 30	Able to moderately use lab work observations into mathematical calculations. 45	Able to fully use lab work observations into mathematical calculations. 60
Safety Adherence Adherence to safety procedures. 10%	Doesn't adhere to safety procedures. 0	Slightly adheres to safety procedures. 10	Somewhat adheres to safety procedures. 20	Moderately adheres to safety procedures. 30	Fully adheres to safety procedures. 40
Equipment Handling Equipment care during the use. 10%	Doesn't handle equipment with required care. 0	Rarely handles equipment with required care. 10	Occasionally handles equipment with required care. 20	Often handles equipment with required care. 30	Handles equipment with required care. 40
Group Work Contributes in a group-based lab work. 10%	Never participates. 0	Rarely participates. 10	Occasionally participates and contributes. 20	Often participates and contributes. 30	Frequently participates and contributes. 40
Total Points (Out of 400)					
Weighted CLO (Psychomotor Score)		(Points /4)			
Remarks					
Instructor's Signature with Date:					

LAB SESSION 10

Introduction to the environment of Over Current Relay (ABB-REF 615)

10.1 General description

The Line-/Feeder protections includes the following protective functionalities:

- Non-directional overcurrent protection ($3I>$, $3I>>$, $3I>>>$)
- Directional earth-fault protection ($I_0> ->$, $I_0>> ->$)
- Non-directional earth-fault protection ($I_0>>$)
- Negative sequence overcurrent protection ($I_2>$), (phase unbalance protection)
- Phase discontinuity protection (I_2/I_1), (phase unbalance protection)
- Auto reclosing function ($O->I$)



Fig. 10.1 Line-/Feeder Protections (REF615)

10.2 Line-/Feeder Protections (physical environment)

The Line-/Feeder Protections has CTs connected on each phase of the protected object as well as a CT measuring the zero sequence current. It also uses voltage transformers connected in an open delta to measure the residual voltage (voltage due to a possible earthfault).

10.2.1 Single Line Diagram (SLD)

In Fig. 10.2 below the single line diagram, SLD, (default start screen, see section 10.3.5.5) of the Line-/Feeder Protections can be seen.

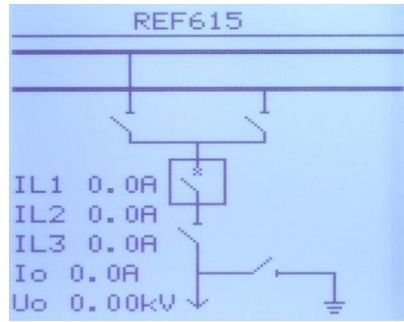

Fig. 10.2 Single Line Diagram (SLD) REF615

The SLD displays the status of the nearby isolators and circuit breakers. The circuit breaker(s) can be controlled (depending on equipment level), either from the HMI (see section 10.3.2) or directly on the PST by means of the circuit breaker switch.

The SLD also shows some of the most essential measurements; phase currents (IL1, IL2, IL3), residual current (Io) and residual voltage (Uo). These measurements and more can also be monitored from the measurements screen (described in section 10.2.2 below).

10.2.2 Measurements

In Fig. 10.3 below the measurements screen (see section 10.3.5 for navigation) of the Line-/Feeder Protections can be seen. The measured quantities are explained in Table 10.1 below.

Fig. 10.3 Measurements screen REF615

Table 10.1 Measurements REF615

Displayed measurement	Description
IL1-A	Current phase 1
IL2-A	Current phase 2
IL3-A	Current phase 3
IO-A	Residual current
U0-kV	Residual voltage
Ng-Seq-A	Negative sequence current

Ps-Seq-A	Positive sequence current
Zro-Seq-A	Zero sequence current

10.2.3 Protective functions

In Table 10.2 below the protective functions for the Line-/Feeder Protections can be seen. All the protective functions below are indicated by means of alarm LEDs (see section 10.3.4) which can be seen in the leftmost column. Each protective function is described in detail in section 10.4.

When a trip occurs, the protective functionalities are set to disconnect different Circuit Breakers (CBs) depending on the severity of the trip. The trip supervised CBs can be seen in the rightmost column.

Table 10.2 Protective functionalities

LED indication name	IEC symbol	Protective functions	General Description	Physical environment
START NON DIR OC				
Trip Non Dir O/C	3I> / 3I>>	PHLPTOC1 / PHHPTOC1 ¹ , PHHPTOC2 ¹	Three-phase nondirectional overcurrent protection, low / high stage.	Detects overcurrent on outgoing lines 1/2 in the Generatorstation, incoming lines 1/2 in the Substation and outgoing feeders 1/2 in the Substation.
Trip Non Dir O/C	3I>>>	PHIPTOC1	Three-phase nondirectional overcurrent protection, instantaneous stage.	See above.
START EARTH FAULT				
Trip Dir E.F.	I _o > -> / I _o >> ->	DEFLPDEF1 ¹ , DEFLPDEF2 ¹ / DEFHPDEF1	Directional earthfault protection, low / high stage.	As described above, but for detection of directional earth-faults.
Trip Non Dir E.F.	I _o >>	EFHPTOC1	Non-directional earth-fault protection, high stage.	As described above, but for detection of nondirectional earth-faults.
START PH UNBALANCE				
Trip Neg Seq O/C	I ₂ >	NSPTOC1 ¹ , NSPTOC2 ¹	Negative-sequence overcurrent protection.	As described above, but for detection of negative sequence overcurrent.
Trip Ph Disc	I ₂ /I ₁ >	PDNSPTOC1	Phase discontinuity.	As described above, but for detection of phase discontinuity.

START AUTO RECLOSING	O-->I	DARREC	Auto reclosing attempts started.	
FAILED AUTO RECLOSING	O-->I	DARREC	Auto reclosing attempts failed.	
<p>1. The final number in the name of the overcurrent-, earth-fault- and negative sequence overcurrent functions is the instance number, meaning that there simply exists a possibility to set several levels of operation for the particular function.</p>				

10.3 Human Machine Interface (Navigation, Control and Indications)

The HMI of the REF615 protection unit can be seen in Fig. 10.4 below. It consists of a graphical display (LCD) showing a Single Line Diagram (SLD) with measurements, buttons for navigation and control, LED indicators and a front communication port.

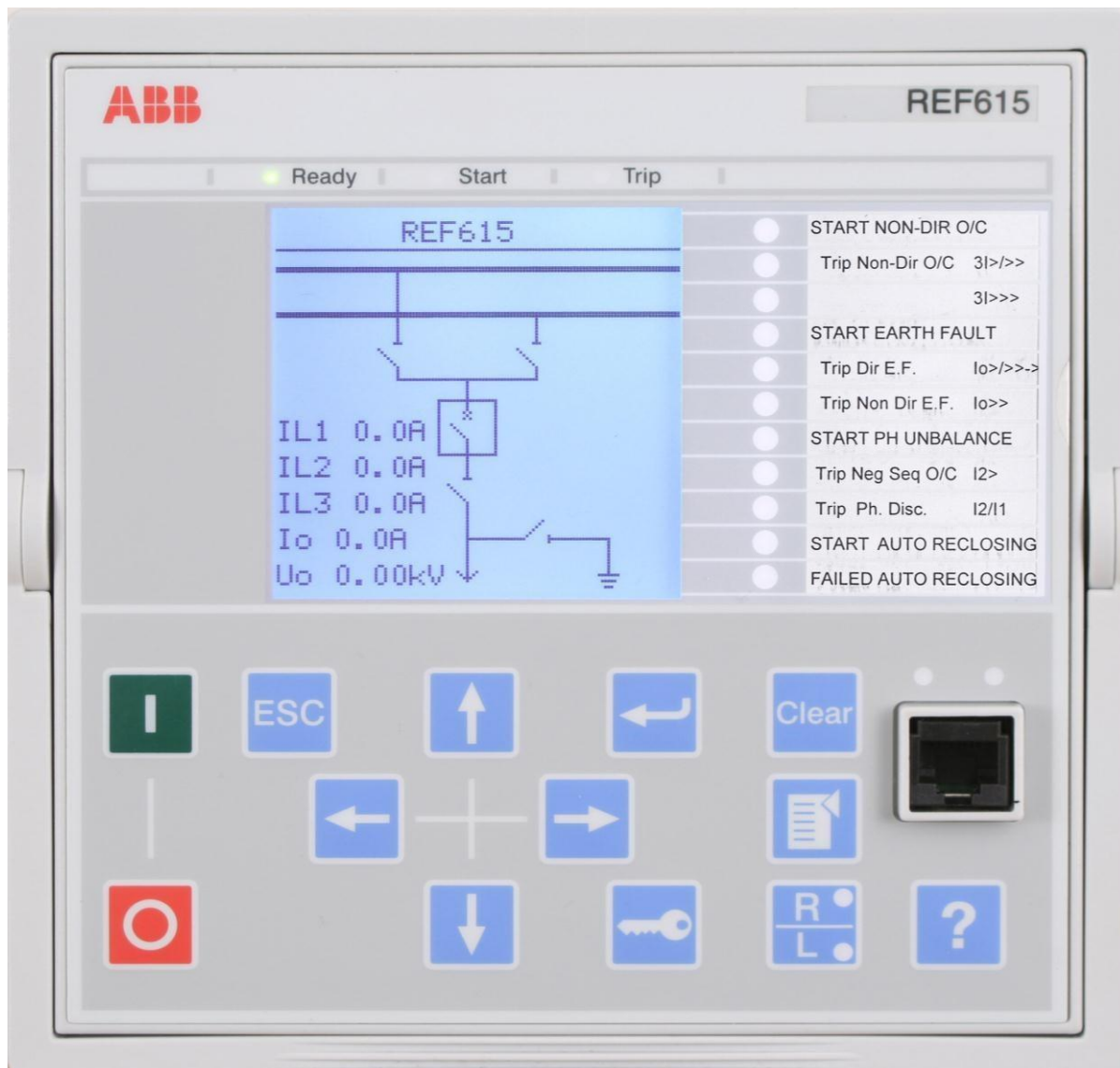

Fig. 10.4 Human Machine Interface REF615

The unit can be controlled/monitored/operated directly from the HMI where for instance subject specific parameters can be configured. Configuration and parameter setting of the protection unit can also be performed from the software Protection and Control IED Manager PCM600.

10.3.1 Graphical display (LCD)

By default the graphical display (LCD) is started showing the Single Line Diagram (Fig. 10.3). The content of the display can be changed by means of the navigation buttons described in section 10.3.2. The display view is divided into four basic areas according to the figure below:

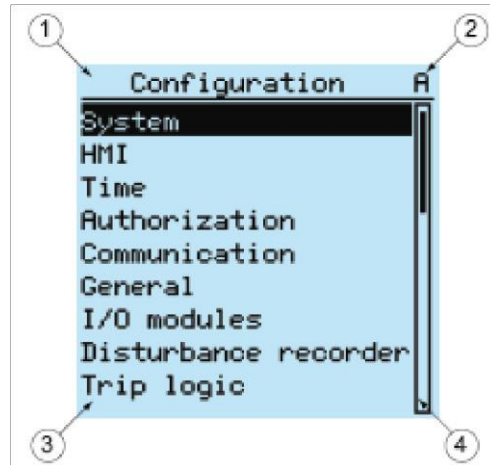

Fig. 10.5 Display layout

1. Header: The header area at the top of the display view shows the current location in the menu structure.
2. Icon: The icon area at the upper right corner of the display shows the current action or user level, accordingly:
 - Current action is indicated by the following characters: U:
 - Font/Firmware is being updated
 - S: Parameters are being stored
 - !: Warning and/or indication
 - Current user level is indicated by the following characters: V:
 - Viewer
 - O: Operator
 - E: Engineer
 - A: Administrator
3. Content: The content area shows the menu content.
4. Scroll bar: If the menu contains more rows than the display can show at a time, a scroll bar is displayed on the right.

10.3.2 Navigation, Command and Control

To navigate in the menu system, make commands and to control the IED, the buttons shown in Fig. 10.6 below are used:

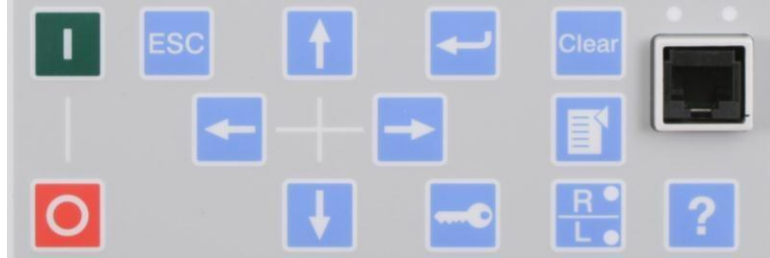

Fig. 10.6 Navigation, Command and Control Buttons

The functionality of each navigation-, command- and control button is described in Table 10.3 Table 10.4 and Table 10.5 below:

Table 10.3 Navigation push-buttons

Name	Description
ESC	<ul style="list-style-type: none"> Leaving setting mode without saving the values Cancelling certain operations Adjusting the display contrast in combination with or Changing the language in combination with . Running the display test in combination with . Deleting a character in combination with when editing a string. Inserting a space in combination with when editing a string.
Enter	<ul style="list-style-type: none"> Entering parameter setting mode. Confirming a new value of a setting parameter.
Up Down	<ul style="list-style-type: none"> Moving up and down in menus. Scrolling active digits of a parameter when entering a new setting value.
Left Right	<ul style="list-style-type: none"> Moving left and right in menus. Changing the active digit of a parameter when entering a new setting value.
Key	<ul style="list-style-type: none"> Activating the authorization procedure, when the user is not logged in. Logging out, when the user is currently logged in.

Table 10.4 Command push-buttons

Name	Description
Menu	<ul style="list-style-type: none"> Moving directly to Main menu, if currently in any other menu or view. Moving between main menu and measurements.
R/L	Changing the control position (remote or local) of the device. <ul style="list-style-type: none"> When the R LED is lit, remote control is enabled and local control disabled. When the L LED is lit, local control is enabled and remote control disabled. When none of the LEDs are lit, both control positions are disabled.





 Clear	<ul style="list-style-type: none"> Activating the Clear/Reset view. Clearing indications and LEDs. The first three-second press clears the indications. The second three-second press clears the programmable LEDs. Requires appropriate user rights.
 Help	Showing context sensitive help messages.

Table 10.5 Control push-buttons

Name	Description
 Close	Closing CB, if currently in local control mode (set by the R/L command button).
 Open	Opening CB, if currently in local control mode (set by the R/L command button).

10.3.3 Protection indicator LEDs

The HMI includes three protection indicators above the display: Ready, Start and Trip, which can be seen in Fig. 10.7 below:

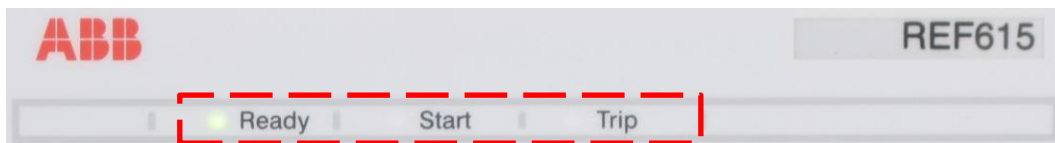

Fig. 10.7 Protection indicator LEDs

The functionalities of the protection indicator LEDs are described in Table 10.6, Table 10.7 and Table 10.8 below:

Table 10.6 Ready LED

LED state	Description
Off	Auxiliary supply voltage is disconnected.
On	Normal operation.
Flashing	Internal fault has occurred or the IED is in test mode. Internal faults are accompanied by an indication message.

Table 10.7 Start LED

LED state	Description
Off	Normal operation.
On	A protection function has started and an indication message is displayed. <ul style="list-style-type: none"> If several protection functions start within a short time, the last start is indicated on the display.
Flashing	A protection function is blocked. <ul style="list-style-type: none"> The blocking indication disappears when the blocking is removed or when the protection function is reset.

Table 10.8 Trip LED

LED state	Description
Off	Normal operation.
On	A protection function has tripped and an indication message is displayed. <ul style="list-style-type: none"> The trip indication is latching and must be reset via communication or by pressing . If several protection functions trip within a short time, the last trip is indicated on the display.

10.3.4 Alarm indicator LEDs

There are also 11 matrix programmable alarm indicator LEDs on the front of the HMI. In the lab, the functionalities have been preprogrammed with the most suitable trip indications shown in Fig. 10.8 below (described in section 10.4):

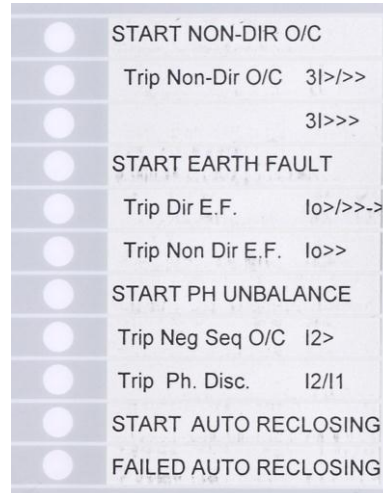

Fig. 10.8 Alarm indicator LEDs

The LEDs can be set in several different modes. In the lab the mode is set to:

LatchedAck-F-S = when a fault is started the START LEDs indicates this by blinking red (○ <-> ●), when the start of the fault is acknowledged the led changes to steady (● <-> ●).

When the fault has tripped the TRIP LEDs indicate this by blinking red (○ <-> ●) and when it is acknowledged and the source of the fault is still present the TRIP LEDs changes to steady (● <-> ●). Acknowledge can be performed when the fault is started and the source of the fault is still on. If the fault has been acknowledged and the source of the fault is gone the LED changes from steady to off. When a trip has been carried out and the source of the fault is gone it is possible to reset the LEDs. If the fault of the trip has not been removed the start and trip will be actuated once again. Acknowledge/Reset of the LEDs can be performed by means of the HMI menu: CLEAR > CLEAR LEDS. Reset of the physical tripping outputs can be performed by means of the HMI menu: CLEAR > CLEAR TRPPTRC1/TRPPTRC2 or by means of the RESET button. The CLEAR menu can also be accessed/used by means of the WHMI (described in section 7).

10.3.5 HMI Menu structure

To facilitate the navigation within the HMI, the illustration in Fig. 10.9 below can be studied. It illustrates the most essential parts of the HMI main menu structure and the adjacent submenus.

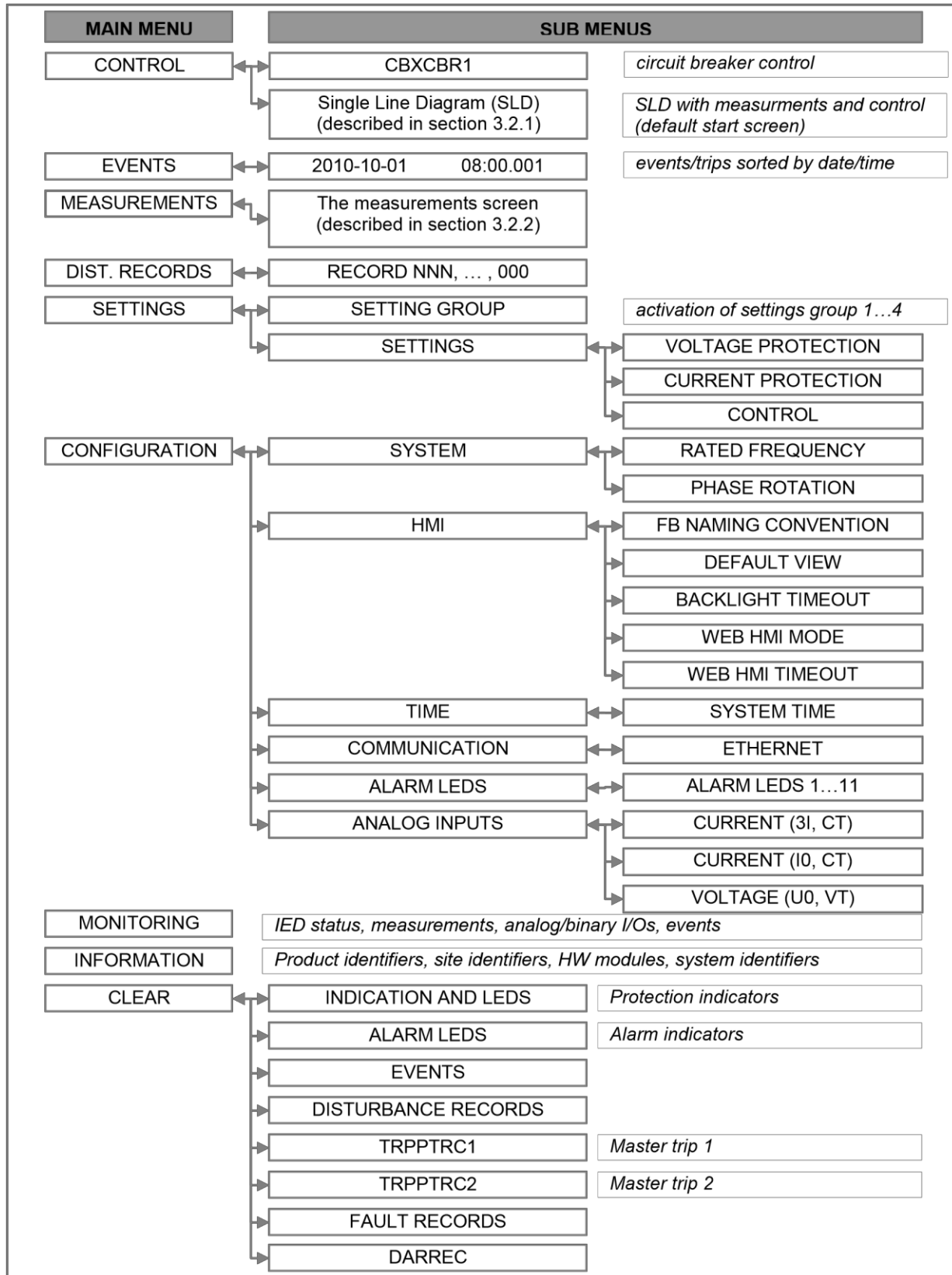

Fig. 10.9 HMI - Main menu structure

10.3.5.1 EVENTS

Log of all internal events including trips which also are recorded in the DISTURBANCE RECORDER.

10.3.5.2 MEASUREMENTS

Displaying phase current, residual current/voltage and negative-/positive- and zero sequence current measurements in accordance with the descriptions in section 10.2.1. The measurements screen is also set as the default start view (CONFIGURATION > HMI > DEFAULT VIEW).

10.3.5.3 DISTURBANCE RECORDS

Keeps records (one for each started event/trip) of trips/disturbances structured with the sub-menus: **GENERAL INFORMATION, INDICATIONS, EVENT RECORDING** and **TRIP VALUES**.

10.3.5.4 SETTINGS

The settings menu comprises subject specific parameters for the different current protection functions. Up to four different groups can be configured and saved individually to be activated and evaluated at the desired moment. The SETTINGS sub-menu together with the essential parameter groups are illustrated in Fig. 10.10 below:

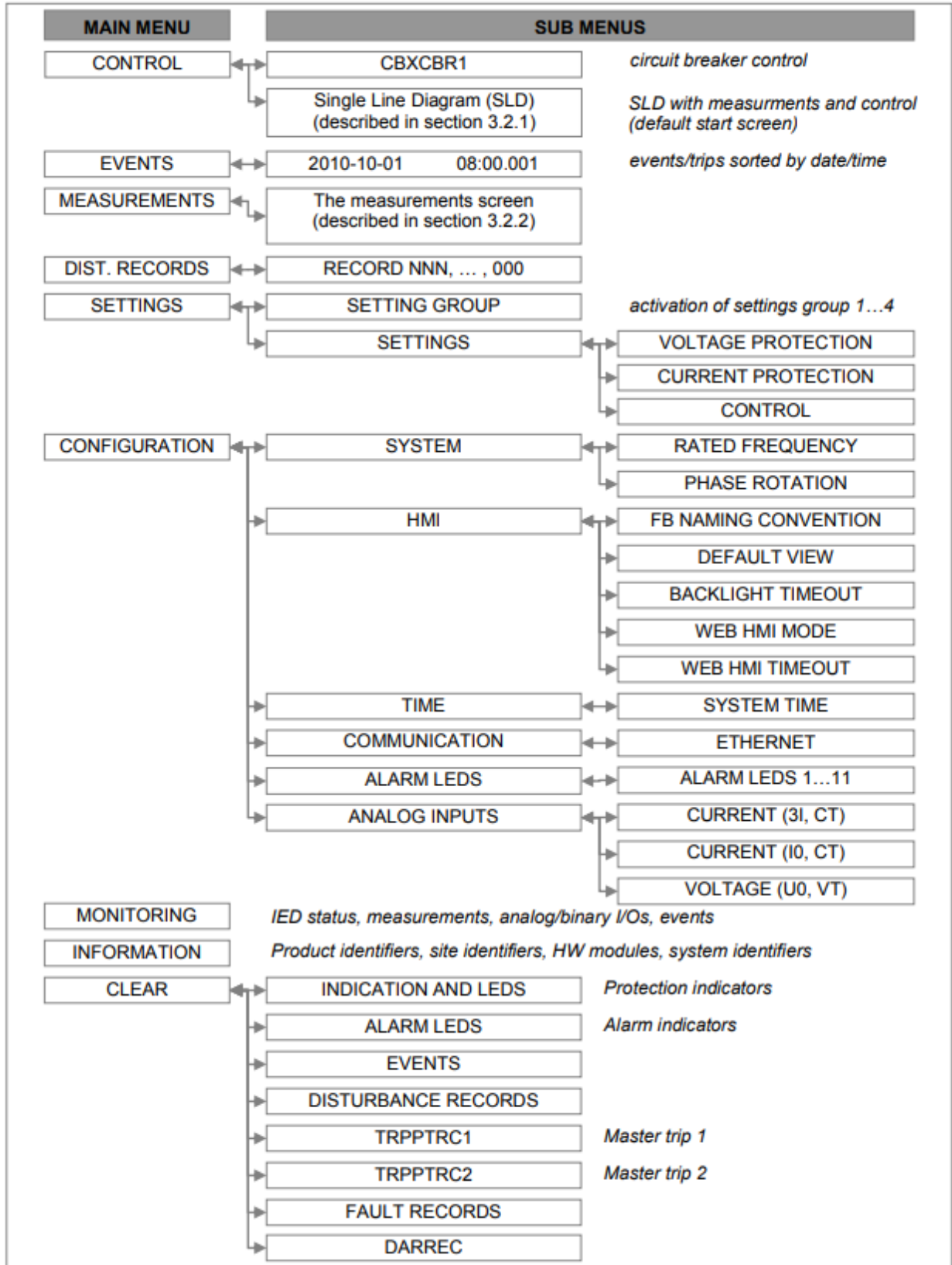

Fig. 10.10 The Settings menu

As you can see in Fig. 10.10 above the protection related groups are expressed in abbreviated terms. The abbreviations follow the well-established IEC61850 standard. Parameters within the different groups above are described in section 10.4.

10.3.5.5 CONFIGURATION

The most essential groups/parameters within the CONFIGURATION sub-menu, can be seen in Fig. 10.11 below:

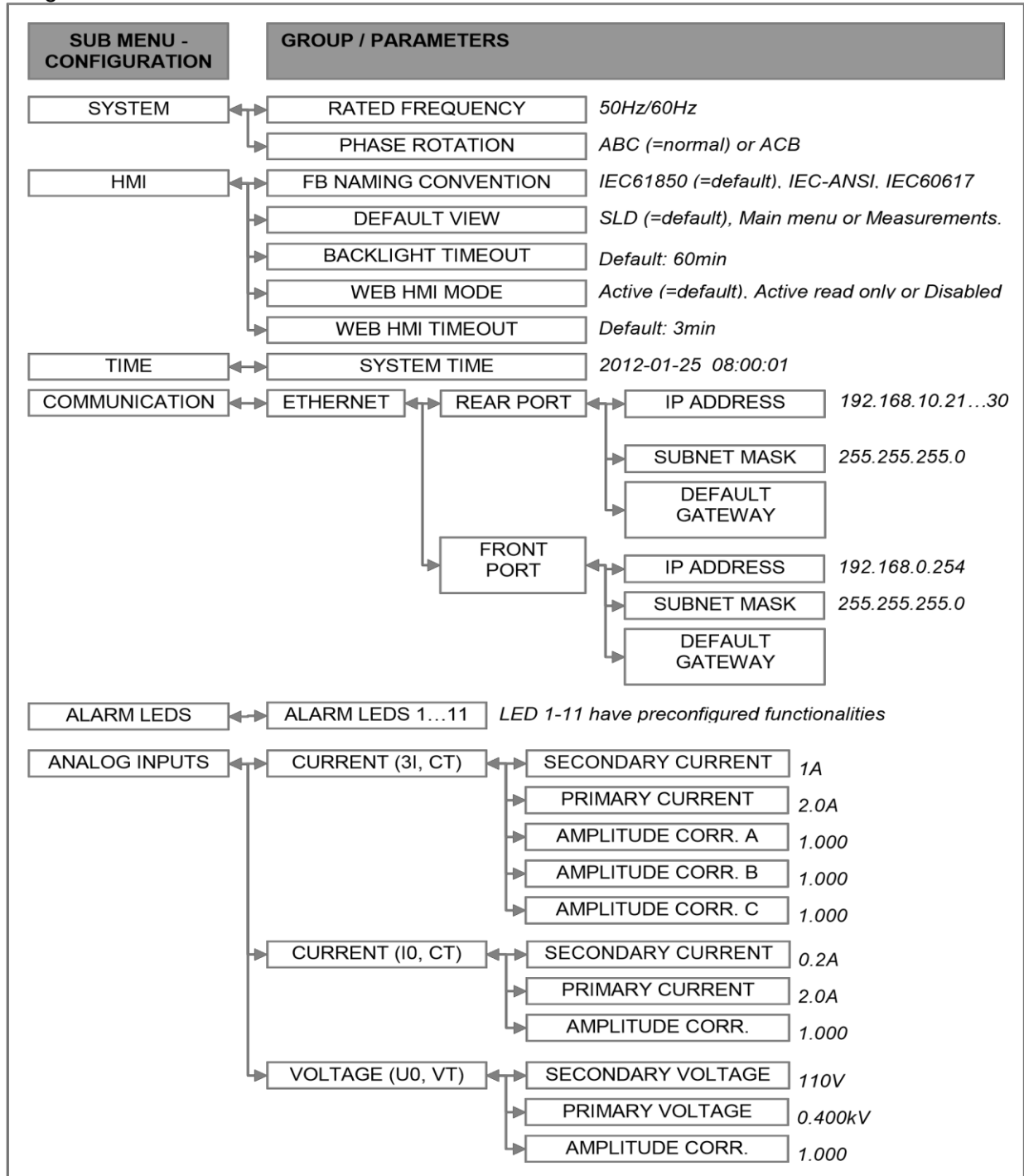

Fig. 10.11 The Configuration menu

SYSTEM contains the configuration of **RATED FREQUENCY** (for instance 50Hz or 60Hz) and **PHASE ROTATION** (normal = ABC or reverse = ACB).

HMI contains the sub-menus **FB NAMING CONVENTION**, **DEFAULT VIEW**, **BACKLIGHT TIMEOUT**, **WEB HMI MODE** and **WEB HMI TIMEOUT**. In **FB NAMING CONVENTION** it is possible to set the protocol according to: IEC61850 (=default), IEC-ANSI or IEC60617. **DEFAULT VIEW** can be set as Measurements (=default, see section 10.2.1) or Main menu. The **BACKLIGHT TIMEOUT** can be set in minutes (default: 60min). **WEB HMI MODE** can be set to Active (=default), Active Read only or Disabled. **WEB HMI TIMEOUT** can be set in minutes (default: 3min).

TIME contains **SYSTEMTIME** in the format: year-month-day, hours:minutes:seconds.

COMMUNICATION contains the sub-menus **ETHERNET > REAR PORT** and **ETHERNET > FRONT PORT**. In **ETHERNET > REAR PORT** configuration of the rear side ethernet port communication parameters is performed and in **ETHERNET > FRONT PORT** configuration of the front side communication port is performed (see section ... for details). By means of the ethernet communication ports it is possible to access the protection unit through PCM600 (described in section 6) or the WHMI (described in section 7).

ALARM LEDS contains information of the preset functionalities of the alarm indication leds (see section 10.3.4).

ANALOG INPUTS contain the sub-menus **CURRENT (3I, CT)**, **CURRENT (I0, CT)** and **VOLTAGE (U0, VT)**. In **CURRENT (3I, CT)** the phase current transformers **SECONDARY CURRENT** (default=1A), **PRIMARY CURRENT** (default=2.0A) and **AMPLITUDE CORR. A/B/C** (default=1.000) is configured. In **CURRENT (I0, CT)** the zero-sequence current transformer **SECONDARY CURRENT** (default=0.2A), **PRIMARY CURRENT** (default=2.0A) and **AMPLITUDE CORR.** (default=1.000) is configured. In **VOLTAGE (U0, VT)** the neutral branch/earth-fault voltage transformer **SECONDARY VOLTAGE** (default=110V), **PRIMARY VOLTAGE** (default=0.400kV) and **AMPLITUDE CORRECTION** (default=1.000) is configured.

10.3.5.6 CLEAR

Within the sub-menu CLEAR it is possible to acknowledge and reset alarms, trips and events. The **CLEAR INDICATION AND LEDS** (covers the protection indicators, see section 10.3.3) and the **CLEAR ALARM LEDS** (covers the alarm indicators, see section 10.3.4) can be used to acknowledge the alarm when the fault is started and the source of the fault is still on. If the fault has been acknowledged and the source of the fault is gone the LEDs changes from steady to off. When a trip has been carried out and the fault of the trip is gone it is possible to reset the LEDs by means of the **CLEAR INDICATION AND LEDS** and the **CLEAR ALARM LEDS**. If the fault of the trip has not been removed the start and trip will be actuated once again. The **CLEAR TRPPTRC1** and **CLEAR TRPPTRC2** clears the master tripping coils (physically connected to tripping outputs for disconnecting CBs) but does not affect the leds indications.

10.4 Parameter descriptions/interpretations

In this section a short description/interpretation is done to the most essential parameters related to the current protections (including earth-fault protection). The protection related groups are expressed in abbreviated terms which follow the well-established IEC61850 standard. Parameter setting can be performed either by means of the HMI (described in section 5), the PCM600 software (described in section 6) or by means of the WHMI

(described in section 7). The navigation to each parameter is facilitated by following the structural maps of the sub-menus illustrated in section 10.3.5 (HMI). The protection functions can be found in the sub-menu Settings > Current (see section 10.3.5.4). For more extensive descriptions of the different protections study the ABB REF615 Technical Manual.

10.4.1 Analog inputs (CTs-/VTs nominal primary-/secondary values)

The **Configuration > Analog inputs** sub-menus **Current (3I, CT)**, **Current (I0, CT)** and **Voltage (U0, VT)** contains settings of the CTs/VTs nominal primary and secondary values. The figures (Fig. 10.12, Fig. 10.13 and Fig. 10.14) below show an extract of the settings.

REF615 - Line 1 Prot. - Parameter Setting					
Group / Parameter Name	IED Value	PC Value	Unit	Min	Max
✓ Current (3I,CT): 1					
✓ Current (3I,CT)					
✓ Secondary current		1A			
✓ Primary current		2,0	A	1,0	6000,0
✓ Amplitude corr. A		1,000		0,900	1,100
✓ Amplitude corr. B		1,000		0,900	1,100
✓ Amplitude corr. C		1,000		0,900	1,100
✓ Reverse polarity		False			

Fig. 10.12 Analog inputs – Current (3I, CT)

REF615 - Line 1 Prot. - Parameter Setting					
Group / Parameter Name	IED Value	PC Value	Unit	Min	Max
✓ Current (I0,CT): 1					
✓ Current (I0,CT)					
✓ Secondary current		0.2A			
✓ Primary current		2,0	A	1,0	6000,0
✓ Amplitude corr.		1,000		0,900	1,100
✓ Reverse polarity		False			

Fig. 10.13 Analog inputs – Current (I0, CT)

REF615 - Line 1 Prot. - Parameter Setting					
Group / Parameter Name	IED Value	PC Value	Unit	Min	Max
✓ Voltage (U0,VT): 1					
✓ Voltage (U0,VT)					
✓ Secondary voltage		110	V	60	210
✓ Primary voltage		0,400	kV	0,100	440,000
✓ Amplitude corr.		1,000		0,900	1,100

Fig. 10.14 Analog inputs – Voltage (U0, VT)

10.4.2 System (Frequency and Phase Rotation)

In the **Configuration > System** sub-menu the **Rated frequency** is set (for instance 50 or 60Hz) together with the **Phase rotation** (Normal = ABC or Inverse = ACB). Default settings according to Fig. 10.15 below:

REF615 - Feeder 1 Protec... (C3) - Parameter Setting					
Group / Parameter Name	IED Value	PC Value	Unit	Min	Max
System: 0					
System					
Rated frequency		50Hz			
Phase rotation		ABC			
Blocking mode		Freeze timer			
Bay name		REF615			20 character(s)
SG follow input		False			

Fig. 10.15 Rated frequency and Phase rotation

10.4.3 Current (EFHPTOC1)

The Non-directional earth-fault protection, (H)igh stage instance 1 (EFHPTOC1), is used as non-directional earth-fault protection for lines/feeders. The function starts and operates when the residual current exceeds the set limit (Start value). The operate time characteristic for high stage EFHPTOC1 can be selected to be either definite time (DT) or inverse definite minimum time (IDMT). In the DT mode, the function operates after a predefined operate time and resets when the fault current disappears. The IDMT mode provides current-dependent timer characteristics.

REF615 - Feeder 1 Protec... (C3) - Parameter Setting					
Group / Parameter Name	IED Value	PC Value	Unit	Min	Max
EFHPTOC1: 1					
IO>>					
Operation		off			
Minimum operate time		3000	ms	20	60000
Reset delay time		20	ms	0	60000
Measurement mode		DFT			
Curve parameter A		28,2000		0,0086	120,0000
Curve parameter B		0,1217		0,0000	0,7120
Curve parameter C		2,00		0,02	2,00
Curve parameter D		29,10		0,46	30,00
Curve parameter E		1,0		0,0	1,0
Setting Group 1			<input checked="" type="checkbox"/>		
Start value		0,20	xIn	0,10	40,00
Start value Mult		1,0		0,8	10,0
Time multiplier		1,00		0,05	15,00
Operate delay time		9000	ms	40	200000
Operating curve type		IEC Def. Time			
Type of reset curve		Immediate			

Fig. 10.16 EFHPTOC1

Definite time characteristics (**Operating curve type = IEC Def. Time**) is recommended for a straight forward basic functionality. The most essential parameters are then (keep other parameters default):

Operation	Enables/disables the function (on/off).
Reset delay time	Defines the time until the Start of a trip is automatically reset if the fault suddenly disappears (value drops below the Start value) before the Operate delay time is exceeded.
Start value	Start value based on the nominal primary current (x In) set in section 10.4.1.
Operate delay time	Defines the delay time until the operation of the function is performed (tripped).

For extensive descriptions of all the different parameters in the non-directional earth-fault protection study the ABB REF615 Technical Manual section 4.

10.4.4 (DEFLPDEF1/2, DEFHPDEF1)

The directional earth-fault protection, (L)ow stage instance 1/2 (DEFLPDEF1/2) and (H)igh stage instance 1 (DEFHPDEF1), is used as a directional earth-fault protection for lines/feeders. The function starts and operates when the operating quantity (current) and polarizing quantity (voltage) exceed the set limits and the angle between them is inside the set operating sector. The operate time characteristic for low stage (DEFLPDEF) and high stage (DEFHPDEF) can be selected to be either definite time (DT) or inverse definite minimum time (IDMT). In the DT mode, the function operates after a predefined operate time and resets when the fault current disappears. The IDMT mode provides current-dependent timer characteristics.

REF615 - Feeder 1 Protec... (C3) - Parameter Setting					
Group / Parameter Name	IED Value	PC Value	Unit	Min	Max
DEFHPDEF1: 1					
ID>>>					
Operation		on			
Reset delay time		20	ms	0	60000
Minimum operate time		60	ms	60	60000
Allow Non Dir		False			
Measurement mode		DFT			
Min operate current		0,005	xIn	0,005	1,000
Min operate voltage		0,01	xUn	0,01	1,00
Correction angle		0,0	deg	0,0	10,0
Pol reversal		False			
Setting Group 1					
Start value		0,10	xIn	0,10	40,00
Start value Mult		1,0		0,8	10,0
Directional mode		Forward			
Time multiplier		1,00		0,05	15,00
Operating curve type		IEC Def. Time			
Type of reset curve		Immediate			
Operate delay time		60	ms	60	200000
Operation mode		Phase angle			
Characteristic angle		-90	deg	-179	180
Max forward angle		88	deg	0	180
Max reverse angle		88	deg	0	180
Min forward angle		88	deg	0	180
Min reverse angle		88	deg	0	180
Voltage start value		0,010	xUn	0,010	1,000
Enable voltage limit		True			

Fig. 10.17 DEFxPDEFx

Definite time characteristics (**Operating curve type = IEC Def. Time**) is recommended for a straight forward basic functionality. The most essential parameters are then (keep other parameters default):

Operation

Enables/disables the function (on/off).

Reset delay time

Defines the time until the **Start** of a tripp is automatically reset if the fault suddenly dissapears (value drops below the **Start value**) before the **Operate delay time** is exceeded.

- Start value** Start value based on the nominal primary current ($x I_n$) set in section 10.4.1.
- Operate delay time** Defines the delay time until the operation of the function is performed (tripped).
- Directional mode** Defines the directionality of the operation as "Non-directional", "Forward" or "Reverse" operation.

For extensive descriptions of all the different parameters in the directional earth-fault protection study the ABB REF615 Technical Manual section 4.

10.4.5 (PHLPTOC1, PHHPTOC1/2, PHIPTOC1)

The three-phase non-directional overcurrent protection, (L)ow stage (PHLPTOC1), (H)igh stage instance number 1/2 (PHHPTOC1/2) and (I)ntermediate stage (PHIPTOC1), is used as one-phase, two-phase or three-phase non-directional overcurrent and short-circuit protection for lines/feeders. The function starts when the current exceeds the set limit (Start value). The operate time characteristics for low stage PHLPTOC and high stage PHHPTOC can be selected to be either definite time (DT) or inverse definite minimum time (IDMT). The instantaneous stage PHIPTOC always operates with the DT characteristic. In the DT mode, the function operates after a predefined operate time and resets when the fault current disappears. The IDMT mode provides current-dependent timer characteristics.

REF615 - Feeder 1 Protec... (C3) - Parameter Setting					
Group / Parameter Name	IED Value	PC Value	Unit	Min	Max
✓ PHHPTOC1: 1					
✓ 3l>>(1)					
✓ Operation		off			
✓ Num of start phases		1 out of 3			
✓ Minimum operate time		20	ms	20	60000
✓ Reset delay time		20	ms	0	60000
✓ Measurement mode		DFT			
✓ Curve parameter A		28,2000		0,0086	120,0000
✓ Curve parameter B		0,1217		0,0000	0,7120
✓ Curve parameter C		2,00		0,02	2,00
✓ Curve parameter D		29,10		0,46	30,00
✓ Curve parameter E		1,0		0,0	1,0
✓ Setting Group 1					
✓ Start value		0,50	xln	0,10	40,00
✓ Start value Mult		1,0		0,8	10,0
✓ Time multiplier		1,00		0,05	15,00
✓ Operate delay time		40	ms	40	200000
✓ Operating curve type		IEC Def. Time			
✓ Type of reset curve		Immediate			

Fig. 10.18 PHxPTOCx

Definite time characteristics (**Operating curve type = IEC Def. Time**) is recommended for a straight forward basic functionality. The most essential parameters are then (keep other parameters default):

- Operation** Enables/disables the function (on/off).
- Num of start phases** Defines the required number of phases (1, 2 or 3 out of 3) exceeding the **Start value** before the start and operation of the function is performed (tripped).
- Reset delay time** Defines the time until the **Start** of a tripp is automatically reset if the fault suddenly dissapears (value drops below the **Start value**) before the **Operate delay time** is exceeded.
- Start value** Start value based on the nominal primary current (**x In**) set in section 10.4.1.
- Operate delay time** Defines the delay time until the operation of the function is performed (tripped).

For extensive descriptions of all the different parameters in the three-phase overcurrent protection study the ABB REF615 Technical Manual section 4.

10.4.6 (NSPTOC1/2)

The negative-sequence overcurrent protection NSPTOC1/2 (instance 1/2) is used for increasing sensitivity to detect single-phase and phase-to-phase faults or unbalanced loads due to, for example, broken conductors or unsymmetrical line/feeder voltages. The function is based on the measurement of the negative sequence current. In a fault situation, the function starts when the negative sequence current exceeds the set limit (Start value). The operate time characteristics can be selected to be either definite time (DT) or inverse definite minimum time (IDMT). In the DT mode, the function operates after a predefined operate time and resets when the fault current disappears. The IDMT mode provides current-dependent timer characteristics.

REF615 - Feeder 1 Protec... (C3) - Parameter Setting					
Group / Parameter Name	IED Value	PC Value	Unit	Min	Max
✓ NSPTOC1: 1					
✓ I2>[1]					
✓ Operation		off			
✓ Minimum operate time		20	ms	20	60000
✓ Reset delay time		20	ms	0	60000
✓ Curve parameter A		28,2000		0,0086	120,0000
✓ Curve parameter B		0,1217		0,0000	0,7120
✓ Curve parameter C		2,00		0,02	2,00
✓ Curve parameter D		29,10		0,46	30,00
✓ Curve parameter E		1,0		0,0	1,0
✓ Setting Group 1			<input checked="" type="checkbox"/>		
✓ Start value		0,30	xIn	0,01	5,00
✓ Start value Mult		1,0		0,8	10,0
✓ Time multiplier		1,00		0,05	15,00
✓ Operate delay time		5000	ms	40	200000
✓ Operating curve type		IEC Def. Time			
✓ Type of reset curve		Immediate			

Fig. 10.19 NSPTOC1/2

Definite time characteristics (**Operating curve type = IEC Def. Time**) is recommended for a straight forward basic functionality. The most essential parameters are then (keep other parameters default):

- Operation** Enables/disables the function (on/off).
- Reset delay time** Defines the time until the **Start** of a tripp is automatically reset if the fault suddenly dissapears (value drops below the **Start value**) before the **Operate delay time** is exceeded.
- Start value** Start value based on the nominal primary current (**x In**) set in section 10.4.1.
- Operate delay time** Defines the delay time until the operation of the function is performed (tripped).

For extensive descriptions of all the different parameters in the negative-sequence overcurrent protection study the ABB REF615 Technical Manual section 4.

10.4.7 Current (PDNSPTOC1)

The phase discontinuity protection PDNSPTOC1 (instance number 1) is used for detecting unbalance situations caused by broken conductors. The function starts and operates when the unbalance current I_2/I_1 exceeds the set limit (**Start value**). The unbalance current is defined as the calculated ratio between the negative (I_2) and positive (I_1) sequence current. To prevent faulty operation at least one phase current needs to be above the minimum level (**Min phase current**). PDNSPTOC1 operates with DT characteristic.

REF615 - Feeder 1 Protec... (C3) - Parameter Setting					
Group / Parameter Name	IED Value	PC Value	Unit	Min	Max
✓ PDNSPTOC1: 1					
✓ $I_2/I_1 >$					
✓ Operation		off			
✓ Reset delay time		20	ms	0	60000
✓ Min phase current		0,30	xIn	0,05	0,30
✓ Setting Group 1			<input checked="" type="checkbox"/>		
✓ Start value		50	%	10	100
✓ Operate delay time		500	ms	100	30000
✓ Setting Group 2					
✓ Start value		10	%	10	100
✓ Operate delay time		100	ms	100	30000
✓ Setting Group 3					
✓ Start value		10	%	10	100
✓ Operate delay time		100	ms	100	30000
✓ Setting Group 4					
✓ Start value		10	%	10	100
✓ Operate delay time		100	ms	100	30000

Fig. 10.20 PDNSPTOC1

The parameters of the function is:

Operation	Sets DARREC on. Default setting on.
Reclosing operation	Sets reclosing on. Default setting on.
Reclaim time	Time from connection until the breaker is initiated ok. (If disconnection is performed within the reclaim time, FAILED AUTO RECLOSING is triggered/signaled).
First reclose time	Default set to 0.5s for automatic reconnection attempt to clear momentary faults.
Operation	Enables/disables the function (on/off).
Reset delay time	Defines the time until the Start of a trip is automatically reset if the fault suddenly disappears (value drops below the Start value) before the Operate delay time is exceeded.
Min phase current	Min phase current based on the nominal primary current (x In) set in section 10.4.1. At least one of the phase currents needs to be above the set limit to enable the function.
Start value	Start value entered in percentage (%). Calculated ratio (I₂/I₁) between the negative (I₂) and positive (I₁) sequence current.
Operate delay time	Defines the delay time until the operation of the function is performed (tripped).

For extensive descriptions of all the different parameters in the phase discontinuity protection study the ABB REF615 Technical Manual section 4.

10.4.8 Auto reclosing (DARREC)

A majority of the faults in overhead lines are transient and automatically cleared with a momentary de-energization of the line. Most of the remaining faults can be cleared by longer interruptions.

The auto reclosing function, DARREC, can be used for automatic reconnection of lines/feeders immediately after a fault and/or after a longer interruption. In case of a permanent fault, the automatic reclosing is followed by a final tripping. A permanent fault must be located and cleared before the fault location can be de-energized.

REF615 - Line 1 Prot. - Parameter Setting					
Group / Parameter Name	IED Value	PC Value	Unit	Min	Max
✓ DARREC1: 1					
✓ 0->I					
✓ Operation		on			
✓ Reclosing operation		On			
✓ Manual close mode		False			
✓ Wait close time		250	ms	50	10000
✓ Max wait time		10000	ms	100	1800000
✓ Max trip time		10000	ms	100	10000
✓ Close pulse time		200	ms	10	10000
✓ Max Thm block time		10000	ms	100	1800000
✓ Cut-out time		10000	ms	0	1800000
✓ Reclaim time		3000	ms	100	1800000
✓ Dsr time shot 1		0	ms	0	10000
✓ First reclose time		500	ms	0	300000
✓ Second reclose time		5000	ms	0	300000
✓ Init signals CBB1		63		0	63
✓ Init signals CBB2		63		0	63
✓ Shot number CBB1		1		0	5
✓ Shot number CBB2		2		0	5

Fig. 3.21 DARREC

The most essential parameters of the function are:

Second reclose time Default set to 5s for automatic reconnection attempt to clear longer faults.

Init signals CBB1 Default set to 63 which allows CBB1 to be triggered at any INIT line (1-6). See table below for detailed explanation.

Init signals CBB2 Default set to 63 which allows CBB2 to be triggered at any INIT line (1-6). See table below for detailed explanation.

Shot number CBB1 Default set to 1. Defines CBB1 = 1st shot.

Shot number CBB2 Default set to 2. Defines CBB2 = 2nd shot.

Observe! The DARREC function is only enabled for auto reclosing when the tripped supervised circuit breaker has been closed by means of the HMI or the WHMI.

The Init signals to CBB1-7 are selected by giving a value which corresponds to a binary code selecting the desired triggering signals of the auto reclosing block. The table below describes the

correlation between the decimal values and the selection of desired trigg signal (operate signals from protective function blocks).

Table 10.9 DARREC Init line signals and connected protective function blocks

Init line signals	INIT 1	INIT 2	INIT 3	INIT 4	INIT 5	INIT 6
Connected functions	PHIPTOC1	PHHPTOC2	PHHPTOC1	DEFHPDEF2	DEFHPDEF1	EFHPTOC1, DEFLPDEF1, PHLPTOC1
Init line values	$2^0 = 1$	$2^1 = 2$	$2^2 = 4$	$2^3 = 8$	$2^4 = 16$	$2^5 = 32$

Example: to have CBB1 to be started from PHHPTOC1 and DEFHPDEF2, simply add the binary values representing INIT 3 line and INIT 5 line, that is $4 + 16 = 20$ entered in the "Init signals CBB1" field.

For extensive descriptions of all the different parameters in the auto reclosing function study the ABB REF615 Technical Manual section 9.



Course Code and Title: _____

Laboratory Session: No. _____ Date: _____

Psychomotor Domain Assessment Rubric-Level P3					
Skill Sets	Extent of Achievement				
	0	1	2	3	4
Equipment Identification Sensory skill to identify equipment and/or its component for a lab work. 10%	Not able to identify the equipment. 0	--	--	--	Able to identify equipment as well as its components. 40
Equipment Use Sensory skills to describe the use of the equipment for the lab work. 15%	Never describes the use of equipment. 0	Rarely able to describe the use of equipment. 15	Occasionally describe the use of equipment. 30	Often able to describe the use of equipment. 45	Frequently able to describe the use of equipment. 60
Procedural Skills Displays skills to act upon sequence of steps in lab work. 15%	Not able to either learn or perform lab work procedure. 0	Able to slightly understand lab work procedure and perform lab work. 15	Able to somewhat understand lab work procedure and perform lab work. 30	Able to moderately understand lab work procedure and perform lab work. 45	Able to fully understand lab work procedure and perform lab work. 60
Response Ability to imitate the lab work on his/her own. 15%	Not able to imitate the lab work. 0	Able to slightly imitate the lab work. 15	Able to somewhat imitate the lab work. 30	Able to moderately imitate the lab work. 45	Able to fully imitate the lab work. 60
Observation's Use Displays skills to perform related mathematical calculations using the observations from lab work. 15%	Not able to use lab work observations into mathematical calculations. 0	Able to slightly use lab work observations into mathematical calculations. 15	Able to somewhat use lab work observations into mathematical calculations. 30	Able to moderately use lab work observations into mathematical calculations. 45	Able to fully use lab work observations into mathematical calculations. 60
Safety Adherence Adherence to safety procedures. 10%	Doesn't adhere to safety procedures. 0	Slightly adheres to safety procedures. 10	Somewhat adheres to safety procedures. 20	Moderately adheres to safety procedures. 30	Fully adheres to safety procedures. 40
Equipment Handling Equipment care during the use. 10%	Doesn't handle equipment with required care. 0	Rarely handles equipment with required care. 10	Occasionally handles equipment with required care. 20	Often handles equipment with required care. 30	Handles equipment with required care. 40
Group Work Contributes in a group-based lab work. 10%	Never participates. 0	Rarely participates. 10	Occasionally participates and contributes. 20	Often participates and contributes. 30	Frequently participates and contributes. 40
Total Points (Out of 400)					
Weighted CLO (Psychomotor Score)		(Points /4)			
Remarks					
Instructor's Signature with Date:					

LAB SESSION 11

**To check the working and functions of ABB REF-615 relay
for earth fault settings.**

Students are required to operate and set the ABB REF-615 relay for different earth fault scenarios. Also, to observe the effect of varying the fault impedance, pickup value and time of operation of relay.



Course Code and Title: _____

Laboratory Session: No. _____ Date: _____

Psychomotor Domain Assessment Rubric-Level P3					
Skill Sets	Extent of Achievement				
	0	1	2	3	4
Equipment Identification Sensory skill to identify equipment and/or its component for a lab work. 10%	Not able to identify the equipment. 0	--	--	--	Able to identify equipment as well as its components. 40
Equipment Use Sensory skills to describe the use of the equipment for the lab work. 15%	Never describes the use of equipment. 0	Rarely able to describe the use of equipment. 15	Occasionally describe the use of equipment. 30	Often able to describe the use of equipment. 45	Frequently able to describe the use of equipment. 60
Procedural Skills Displays skills to act upon sequence of steps in lab work. 15%	Not able to either learn or perform lab work procedure. 0	Able to slightly understand lab work procedure and perform lab work. 15	Able to somewhat understand lab work procedure and perform lab work. 30	Able to moderately understand lab work procedure and perform lab work. 45	Able to fully understand lab work procedure and perform lab work. 60
Response Ability to imitate the lab work on his/her own. 15%	Not able to imitate the lab work. 0	Able to slightly imitate the lab work. 15	Able to somewhat imitate the lab work. 30	Able to moderately imitate the lab work. 45	Able to fully imitate the lab work. 60
Observation's Use Displays skills to perform related mathematical calculations using the observations from lab work. 15%	Not able to use lab work observations into mathematical calculations. 0	Able to slightly use lab work observations into mathematical calculations. 15	Able to somewhat use lab work observations into mathematical calculations. 30	Able to moderately use lab work observations into mathematical calculations. 45	Able to fully use lab work observations into mathematical calculations. 60
Safety Adherence Adherence to safety procedures. 10%	Doesn't adhere to safety procedures. 0	Slightly adheres to safety procedures. 10	Somewhat adheres to safety procedures. 20	Moderately adheres to safety procedures. 30	Fully adheres to safety procedures. 40
Equipment Handling Equipment care during the use. 10%	Doesn't handle equipment with required care. 0	Rarely handles equipment with required care. 10	Occasionally handles equipment with required care 20	Often handles equipment with required care. 30	Handles equipment with required care. 40
Group Work Contributes in a group-based lab work. 10%	Never participates. 0	Rarely participates. 10	Occasionally participates and contributes. 20	Often participates and contributes. 30	Frequently participates and contributes. 40
Total Points (Out of 400)					
Weighted CLO (Psychomotor Score)		(Points /4)			
Remarks					
Instructor's Signature with Date:					

LAB SESSION 12

Introduction to the operating environment of Differential Relay (ABB-RET 615)

12.1 General description

In Fig. 12.1 below the differential relay can be seen. The differential protection is used to protect busbars, generators and transformers in a power system. This model of the differential relay includes the following protective functionalities:

- ✦ Differential protection (3dI>T)
- ✦ Non-directional overcurrent protection (3I>, 3I>>, 3I>>>)



Fig. 12.1 Differential protection (RET615)

12.2 Physical Environment

The differential protection has CTs connected on the incoming and outgoing sides of the equipment.

12.2.1 Measurements

In Fig. 12.2 and Fig. 12.3 below the measurements screen. The measured quantities are further on explained in Table 12.1 below.

RET615	
IL1-A	0.0
IL2-A	0.0
IL3-A	0.0
IL1B-A	0.0
IL2B-A	0.0
IL3B-A	0.0
IOB-A	0.0

Fig. 12.2 Measurement screen RET615 (left=upper displayed)

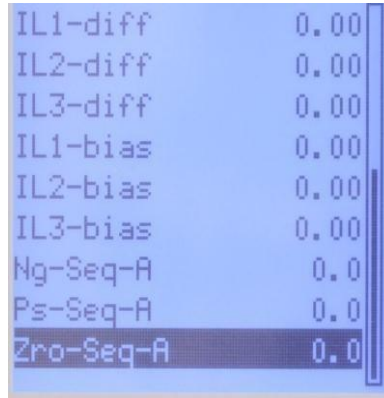

Fig. 12.3 Measurement screen RET615 (lower displayed, scrolled down)

Table 12.1 Measurements RET615

Displayed measurement	Description
IL1-A	Current phase 1 (winding 1)
IL2-A	Current phase 2 (winding 1)
IL3-A	Current phase 3 (winding 1)
IL1B-A	Current phase 1 (winding 2)
IL2B-A	Current phase 2 (winding 2)
IL3B-A	Current phase 3 (winding 2)
I0B-A	Residual current (winding 2)
IL1-diff	Differential current phase 1
IL2-diff	Differential current phase 2
IL3-diff	Differential current phase 3
IL1-bias	Bias current phase 1
IL2-bias	Bias current phase 2
IL3-bias	Bias current phase 3
Ng-Seq-A	Negative sequence current (winding 1)
Ps-Seq-A	Positive sequence current (winding 1)
Zro-Seq-A	Zero sequence current (winding 1)

12.2.2 Protective functions

In Table 12.2 below the protective functions for the Differential protection can be seen. All the protective functions below are indicated by means of alarm LEDs (see section 12.3.4) which can be seen in the leftmost column. Each protective function is described in detail in section 12.4.

When a trip occurs the protective functionalities are set to disconnect different Circuit Breakers (CBs) depending on the severity of the trip.

Table 12.2 Protective functionalities

LED indication name	IEC symbol	Protective functions	General Description	Physical environment

TRIP Diff low set	3dI>T	TR2PTDF1 ² : OPR_LS (low operate value)	Generator (/Transformer) differential protection. Low operate value.	Detects differential currents between the Generator neutral branch side = winding 1 and the Generator outgoing side = winding 2.
TRIP Diff high set	3dI>T	TR2PTDF1 ² : OPR_HS (high operate value)	Generator (/Transformer) differential protection. High operate value.	See above.
START O/C				
Trip Non Dir O/C	3I>	PHLPTOC1 ¹ , PHLPTOC2 ¹	Three-phase nondirectional overcurrent protection, low stage (winding 1 and 2).	As described above, but for detection of overcurrent.
Trip Non Dir O/C	3I>>	PHHPTOC1 ¹ , PHHPTOC2 ¹	Three-phase nondirectional overcurrent protection, high stage (winding 1 and 2).	See above.
Trip Non Dir O/C	3I>>>	PHIPTOC1 ¹ , PHIPTOC2 ¹	Three-phase nondirectional overcurrent protection, instantaneous stage (winding 1 and 2).	See above.

¹.

The final number in the name of the over current- and earth-fault functions indicates if the function is connected to winding 1 or winding 2. ².

The final number in the name of the differential functions is the instance number, meaning that there might exist a possibility to set several levels of operation for the particular function.

12.3 Human Machine Interface (Navigation and Indications)

The HMI of the RET615 protection unit can be seen in Fig. 12.4 below. It consists of a graphical display (LCD), buttons for control/navigation, LED indicators and a front communication port.



Fig. 12.4 Human Machine Interface RET615

The unit can be controlled/monitored/operated directly from the HMI where for instance subject specific parameters can be configured. Configuration and parameter setting of the protection unit can also be performed from the software Protection and Control IED Manager PCM600 (described in section 6) or from the WHMI (described in section 7).

12.3.1 Graphical display (LCD)

By default the graphical display (LCD) is started showing the measurements screen (Fig. 12.2 and Fig. 12.3). The content of the display can be changed by means of the navigation buttons described in section 12.3.2. The display view is divided into four basic areas according to the figure below:

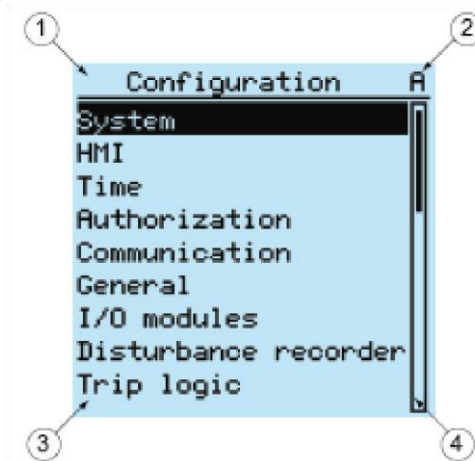

Fig. 12.5 Display layout

5. Header: The header area at the top of the display view shows the current location in the menu structure.
6. Icon: The icon area at the upper right corner of the display shows the current action or user level, accordingly:
 - Current action is indicated by the following characters: U:
 - Font/Firmware is being updated
 - S: Parameters are being stored
 - !: Warning and/or indication
 - Current user level is indicated by the following characters: V:
 - Viewer
 - O: Operator
 - E: Engineer
 - A: Administrator
7. Content: The content area shows the menu content.
8. Scroll bar: If the menu contains more rows than the display can show at a time, a scroll bar is displayed on the right.

12.3.2 Navigation

To navigate in the menu system etc. the navigation buttons are used, shown in Fig. 12.6 below:

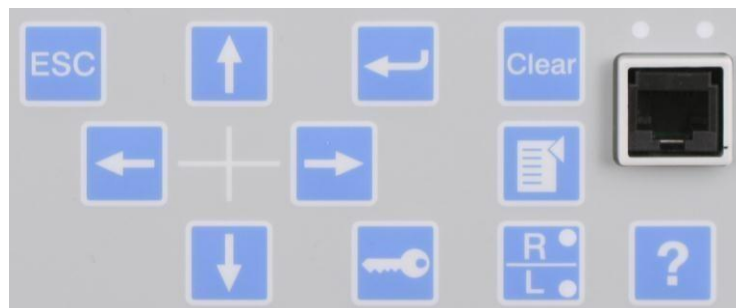

Fig. 12.6 Navigation Buttons

The functionality of each navigation- and command button is described in Table 12.3 and Table 12.4 below:

Table 12.3 Navigation push-buttons

















Name	Description
 ESC	<ul style="list-style-type: none"> ✦ Leaving setting mode without saving the values ✦ Cancelling certain operations ✦ Adjusting the display contrast in combination with  or  combination ✦ Changing the language in combination with  . ✦ Running the display test in combination with  . ✦ Deleting a character in combination with  when editing a string. ✦ Inserting a space in combination with  when editing a string.
 Enter	<ul style="list-style-type: none"> ✦ Entering parameter setting mode. ✦ Confirming a new value of a setting parameter.
 Up  Down	<ul style="list-style-type: none"> ✦ Moving up and down in menus. ✦ Scrolling active digits of a parameter when entering a new setting value.
 Left  Right	<ul style="list-style-type: none"> ✦ Moving left and right in menus. ✦ Changing the active digit of a parameter when entering a new setting value.
 Key	<ul style="list-style-type: none"> ✦ Activating the authorization procedure, when the user is not logged in. ✦ Logging out, when the user is currently logged in.

Table 12.4 Command push-buttons

Name	Description
 Menu	<ul style="list-style-type: none"> ✦ Moving directly to Main menu, if currently in any other menu or view. ✦ Moving between main menu and measurements.
 R/L	<p>Changing the control position (remote or local) of the device.</p> <ul style="list-style-type: none"> ✦ When the R LED is lit, remote control is enabled and local control disabled. ✦ When the L LED is lit, local control is enabled and remote control disabled. ✦ When none of the LEDs are lit, both control positions are disabled.
 Clear	<ul style="list-style-type: none"> ✦ Activating the Clear/Reset view. ✦ Clearing indications and LEDs. The first three-second press clears the indications. The second three-second press clears the programmable LEDs. Requires appropriate user rights.
 Help	Showing context sensitive help messages.

12.3.3 Protection indicator LEDs

The HMI includes three protection indicators above the display: Ready, Start and Trip, which can be seen in Fig. 12.7 below:

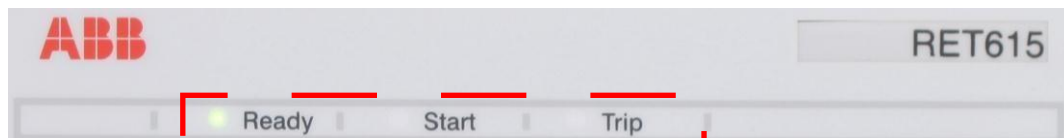

Fig. 12.7 Protection indicator LEDs

The functionalities of the protection indicator LEDs are described in Table 12.5, Table 12.6 and Table 12.7 below:

Table 12.5 Ready LED

LED state	Description
Off	Auxiliary supply voltage is disconnected.
On	Normal operation.
Flashing	Internal fault has occurred or the IED is in test mode. Internal faults are accompanied by an indication message.

Table 12.6 Start LED

LED state	Description
Off	Normal operation.
On	A protection function has started and an indication message is displayed. † If several protection functions start within a short time, the last start is indicated on the display.
Flashing	A protection function is blocked. † The blocking indication disappears when the blocking is removed or when the protection function is reset.

Table 12.7 Trip LED

LED state	Description
Off	Normal operation.
On	A protection function has tripped and an indication message is displayed. † The trip indication is latching and must be reset via communication or by  pressing. † If several protection functions trip within a short time, the last trip is indicated on the display.

12.3.4 Alarm indicator LEDs

There are also 11 matrix programmable alarm indicator LEDs on the front of the HMI. In the lab, the functionalities have been preprogrammed with the most suitable trip indications shown in Fig. 12.8 below (described in section 12.2.2 and 12.4):

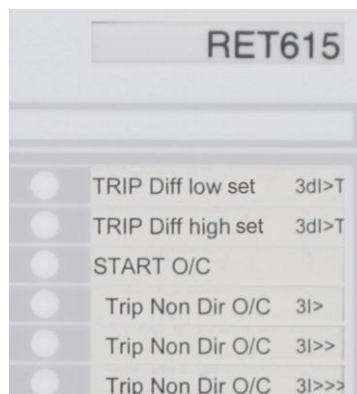







Fig. 12.8 Alarm indicator LEDs

The LEDs can be set in several different modes. In the lab the mode is set to:

LatchedAck-F-S = when a fault is started the START LEDs indicates this by blinking red (), when the start of the fault is acknowledged the led changes to steady (). When the fault has tripped the TRIP LEDs indicate this by blinking red () and when it is acknowledged and the source of the fault is still present the TRIP LEDs changes to  

steady (<->). Acknowledge can be performed when the fault is started and the source of the fault is still on. If the fault has been acknowledged and the source of the fault is gone the LED changes from steady to off. When a trip has been carried out and the source of the fault is gone it is possible to reset the LEDs. If the fault of the trip has not been removed the start and trip will be actuated once again. Acknowledge/Reset of the LEDs can be performed by means of the HMI menu: CLEAR > CLEAR LEDS. Reset of the physical tripping outputs can be performed by means of the HMI menu: CLEAR > CLEAR TRPPTRC1/TRPPTRC2 or by means of the RESET. The CLEAR menu can also be accessed/used by means of the WHMI (described in section 7).

12.3.5 HMI Menu structure

To facilitate the navigation within the HMI the illustration in Fig. 12.9 below can be studied. It illustrates the most essential parts of the HMI main menu structure and the adjacent submenus.

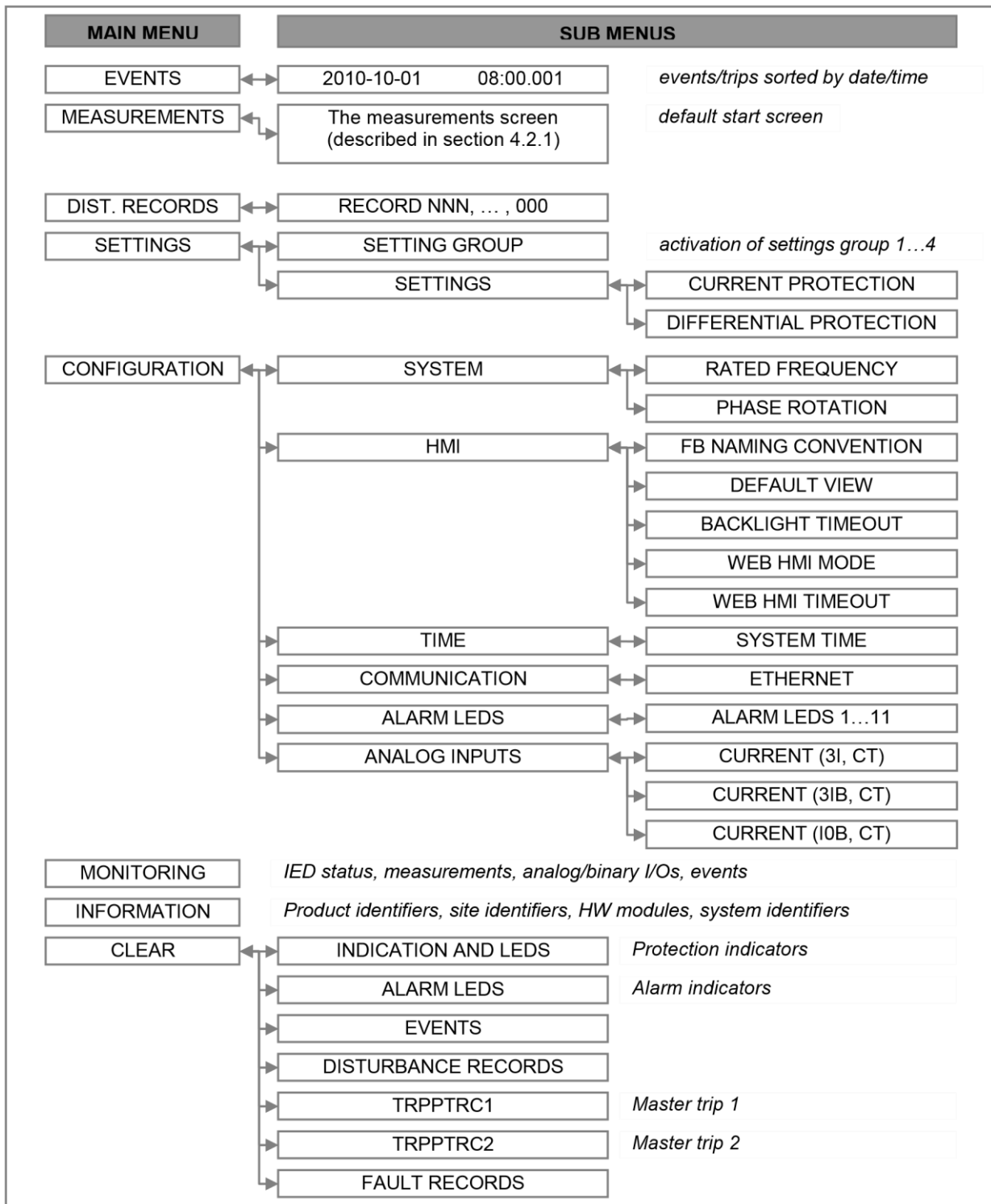

Fig. 12.9 HMI - Main menu structure

12.3.5.1 EVENTS

Log of all internal events including trips which also are recorded in the DISTURBANCE RECORDER.

12.3.5.2 MEASUREMENTS

Displaying phase current, residual current/voltage and negative/positive and zero sequence current measurements in accordance with the descriptions in section 12.3.2.1. The

measurements screen is also set as the default start view (CONFIGURATION > HMI > DEFAULT VIEW).

12.3.5.3 DISTURBANCE RECORDS

Keeps records (one for each started event/trip) of trips/disturbances structured with the sub-menus: **GENERAL INFORMATION, INDICATIONS, EVENT RECORDING** and **TRIP VALUES**.

12.3.5.4 SETTINGS

The settings menu comprises subject specific parameters for the different current protection functions. Up to four different groups can be configured and saved individually to be activated and evaluated at the desired moment. The SETTINGS sub-menu together with the essential parameter groups are illustrated in Fig. 12.10 below:

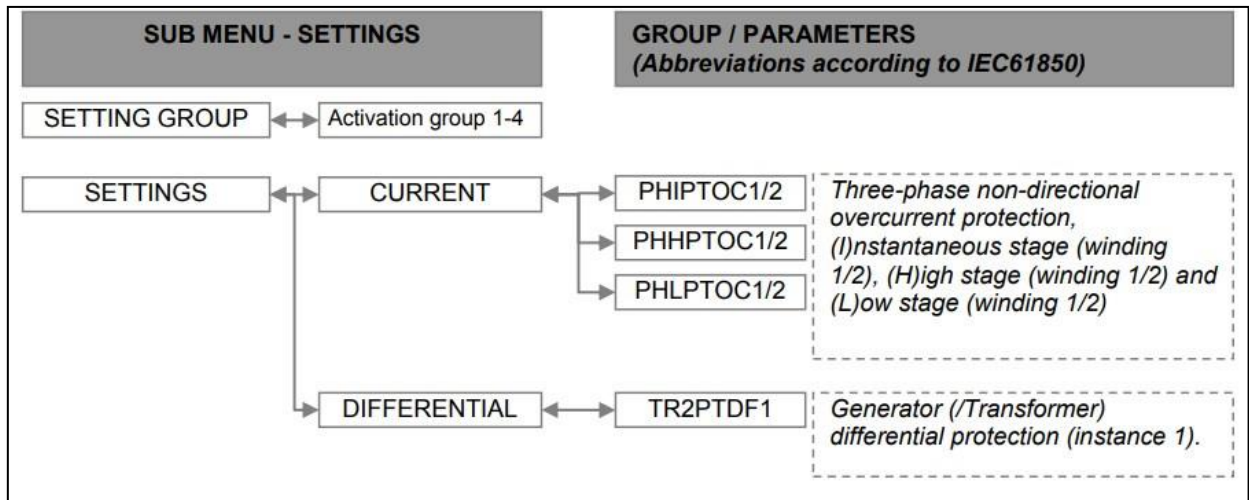

Fig. 12.10 The Settings menu

As you can see in Fig. 12.10 above the protection related groups are expressed in abbreviated terms. The abbreviations follow the well established IEC61850 standard. Parameters within the different groups above are described in section 12.4.

12.3.5.5 CONFIGURATION

The most essential groups/parameters within the CONFIGURATION sub-menu, can be seen in Fig. 12.11 below:

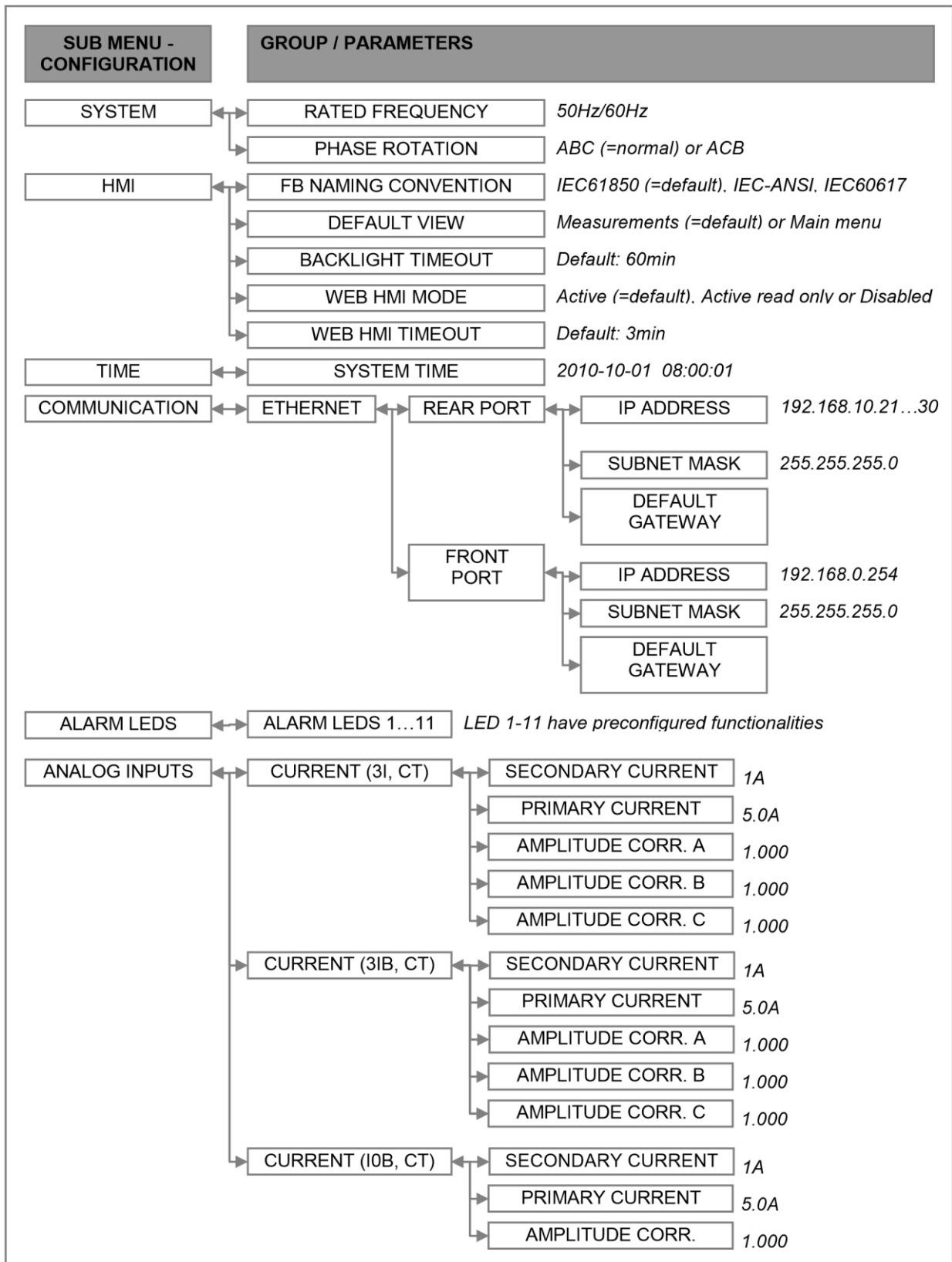

Fig. 12.11 The Configuration menu

SYSTEM contains the configuration of **RATED FREQUENCY** (for instance 50Hz or 60Hz) and **PHASE ROTATION** (normal = ABC or reverse = ACB).

HMI contains the sub-menus **FB NAMING CONVENTION**, **DEFAULT VIEW**, **BACKLIGHT TIMEOUT**, **WEB HMI MODE** and **WEB HMI TIMEOUT**. In **FB NAMING CONVENTION** it is

possible to set the protocol according to: IEC61850 (=default), IEC-ANSI or IEC60617. **DEFAULT VIEW** can be set as Measurements (=default, see section 3.2.1) or Main menu. The **BACKLIGHT TIMEOUT** can be set in minutes (default: 60min). **WEB HMI MODE** can be set to Active (=default), Active Read only or Disabled. **WEB HMI TIMEOUT** can be set in minutes (default: 3min).

TIME contains **SYSTEMTIME** in the format: year-month-day, hours:minutes:seconds.

COMMUNICATION contains the sub-menus **ETHERNET > REAR PORT** and **ETHERNET > FRONT PORT**. In **ETHERNET > REAR PORT** configuration of the rear side ethernet port communication parameters is performed and in **ETHERNET > FRONT PORT** configuration of the front side communication port is performed (see section ... for details). By means of the ethernet communication ports it is possible to access the protection unit through PCM600 (described in section 6) or the WHMI (described in section 7).

ALARM LEDS contains information of the preset functionalities of the alarm indication LEDS (see section 12.3.4).

ANALOG INPUTS contains the sub-menus **CURRENT (3I, CT)**, **CURRENT (3IB, CT)** and **CURRENT (I0B, CT)**. In **CURRENT (3I, CT)** the phase current transformers **SECONDARY CURRENT** (default=1A), **PRIMARY CURRENT** (default=5.0A) and **AMPLITUDE CORR. A/B/C** (default=1.000) is configured. In **CURRENT (3IB, CT)** the phase current transformers **SECONDARY CURRENT** (default=1A), **PRIMARY CURRENT** (default=5.0A) and **AMPLITUDE CORR. A/B/C** (default=1.000) is configured. In **CURRENT (I0B, CT)** the zero sequence current **SECONDARY CURRENT** (default=1A), **PRIMARY CURRENT** (default=5.0A) and **AMPLITUDE CORR.** (default=1.000) is configured.

12.3.5.6 CLEAR

Within the sub-menu CLEAR it is possible to acknowledge and reset alarms, trips and events. The **CLEAR INDICATION AND LEDS** (covers the protection indicators, see section 3.3.3) and the **CLEAR ALARM LEDS** (covers the alarm indicators, see section 3.3.4) can be used to acknowledge the alarm when the fault is started and the source of the fault is still on. If the fault has been acknowledged and the source of the fault is gone the LEDs changes from steady to off. When a trip has been carried out and the fault of the trip is gone it is possible to reset the LEDs by means of the **CLEAR INDICATION AND LEDS** and the **CLEAR ALARM LEDS**. If the fault of the trip has not been removed the start and trip will be actuated once again. The **CLEAR TRPPTRC1** and **CLEAR TRPPTRC2** clears the master tripping coils (physically connected to tripping outputs for disconnecting CBs) but does not affect the leds indications.

12.4 Parameter descriptions/interpretations

In this section a short description/interpretation is done to the most essential parameters related to the current protection and the differential protection. The protection related groups are expressed in abbreviated terms which follow the well established IEC61850 standard. Parameter setting can be performed either by means of the HMI (described in section 5), the PCM600 software (described in section 6) or by means of the WHMI (described in section 7). The navigation to each parameter is facilitated by following the structural maps of the submenus illustrated in section 12.3.5 (HMI). The protection functions can be found in the submenu Settings > Current (see section 12.3.5.4). For more extensive descriptions of the different protections study the ABB RET615 Technical Manual.

12.4.1 Analog inputs (CTs nominal primary-/secondary values)

The **Configuration > Analog inputs** sub-menus **Current (3I, CT)**, **Current (3IB, CT)** and **Current (I0B, CT)** contains settings of the CTs nominal primary and secondary values. Below, in Fig. 12.12, Fig. 12.13 and Fig. 12.14, examples of the settings can be seen.

RET615 - G1 Protection (C2) - Parameter Setting					
Group / Parameter Name	IED Value	PC Value	Unit	Min	Max
✓ Current (3I,CT): 1					
✓ Current (3I,CT)					
✓ Secondary current		1A			
✓ Primary current		2,0	A	1,0	6000,0
✓ Amplitude corr. A		1,000		0,900	1,100
✓ Amplitude corr. B		1,000		0,900	1,100
✓ Amplitude corr. C		1,000		0,900	1,100

Fig. 12.12 Analog inputs – Current (3I, CT)

RET615 - G1 Protection (C2) - Parameter Setting					
Group / Parameter Name	IED Value	PC Value	Unit	Min	Max
✓ Current (3IB,CT): 2					
✓ Current (3IB,CT)					
✓ Secondary current		1A			
✓ Primary current		2,0	A	1,0	6000,0
✓ Amplitude corr. A		1,000		0,900	1,100
✓ Amplitude corr. B		1,000		0,900	1,100
✓ Amplitude corr. C		1,000		0,900	1,100

Fig. 12.13 Analog inputs – Current (3IB, CT)

RET615 - G1 Protection (C2) - Parameter Setting					
Group / Parameter Name	IED Value	PC Value	Unit	Min	Max
✓ Current (I0B,CT): 2					
✓ Current (I0B,CT)					
✓ Secondary current		1A			
✓ Primary current		2,0	A	1,0	6000,0
✓ Amplitude corr.		1,000		0,900	1,100

Fig. 12.14 Analog inputs – Current (I0B, CT)

12.4.2 System (Frequency and Phase Rotation)

In the **Configuration > System** sub-menu the **Rated frequency** is set (for instance 50 or 60Hz) together with the **Phase rotation** (Normal = ABC or Inverse = ACB). Default settings according to Fig. 12.15 below:

RET615 - G1 Protection (C2) - Parameter Setting					
Group / Parameter Name	IED Value	PC Value	Unit	Min	Max
✓ System: 0					
✓ System					
✓ Rated frequency		50Hz			
✓ Phase rotation		ABC			
✓ Blocking mode		Freeze timer			
✓ Bay name		RET615			20 character
✓ SG follow input		False			

Fig. 12.15 Rated frequency and Phase rotation

12.4.3 Differential (TR2PTDF1)

The transformer differential protection TR2PTDF is designed to protect two-winding transformers and generator-transformer blocks. TR2PTDF includes low biased and high instantaneous stages.

The biased low stage provides a fast clearance of faults while remaining stable with high currents passing through the protected zone increasing errors on current algorithms, ensures that the low stage does not operate due to the transformer inrush currents. The fifth harmonic restraint ensures that the low stage does not operate on apparent differential current caused by a harmless transformer overexcitation. The instantaneous high stage provides a very fast clearance of severe faults with a high differential current regardless of their harmonics.

RET615 - G1 Protection (C2) - Parameter Setting					
Group / Parameter Name	IED Value	PC Value	Unit	Min	Max
✓ TR2PTDF1: 1					
✓ 3dI>T					
✓ Operation		on			
✓ CT connection type		Type 2			
✓ Winding 1 type		Y			
✓ Winding 2 type		y			
✓ Clock number		Clk Num 0			
✓ Zero A elimination		Not eliminated			
✓ Min winding tap		36		-36	36
✓ Max winding tap		0		-36	36
✓ Tap nominal		18		-36	36
✓ Tapped winding		Not in use			
✓ Step of tap		1.50	%	0.60	9.00
✓ CT ratio Cor Wnd 1		1.00		0.40	4.00
✓ CT ratio Cor Wnd 2		1.00		0.40	4.00
✓ Setting Group 1					
✓ High operate value		1000	%I _r	500	3000
✓ Enable high set		True			
✓ Low operate value		20	%I _r	5	50
✓ Slope section 2		30	%	10	50
✓ End section 2		150	%I _r	100	500
✓ Restraint mode		2.h + 5.h + wav			
✓ Harmonic deblock 2		True			
✓ Start value 2.H		15	%	7	20
✓ Start value 5.H		35	%	10	50
✓ Stop value 5.H		35	%	10	50
✓ Harmonic deblock 5		False			

Fig. 12.17 TR2PTDF1

12.4.4.1 Differential calculation

TR2PTDF operates phase-wise on a difference of incoming and outgoing currents. The positive direction of the currents is defined towards the protected object.

The differential current is defined accordingly:

$$I_d = I_{W1} - I_{W2}$$

In a normal situation, no fault occurs in the area protected by TR2PTDF. Then the currents I_{W1} and I_{W2} are equal and the differential current I_d is zero. In practice, however, the differential current deviates from zero in normal situations. In the power transformer protection, the differential current is caused by CT inaccuracies, transformer no-load current and instantaneous transformer inrush currents. An increase in the load current causes the differential current, caused by the CT inaccuracies, to grow at the same percentage rate.

12.4.4.2 Parameter descriptions

For extensive descriptions of all the different parameters in the differential protection study the ABB RET615 Technical Manual section 4.

Operation

Simply enables/disables the differential function (on/off).

CT connection type

Presumed that the phase currents on each side of the protected object are defined according to Fig. 12.19 and Fig. 12.20 below (in this case the protected object is the generator stator where both sides are galvanically the same which makes this assumption fore filled), the CT connection type can be set in two different types (Type 1 and Type 2). CT connection Type 1 (Fig. 12.19) defines that the secondary side currents of the CT's on each side of the protected object, are in opposite directions. Whereas CT connection Type 2 (Fig. 12.20) defines that the secondary side currents of the CT's on each side of the protected object, are in the same directions.

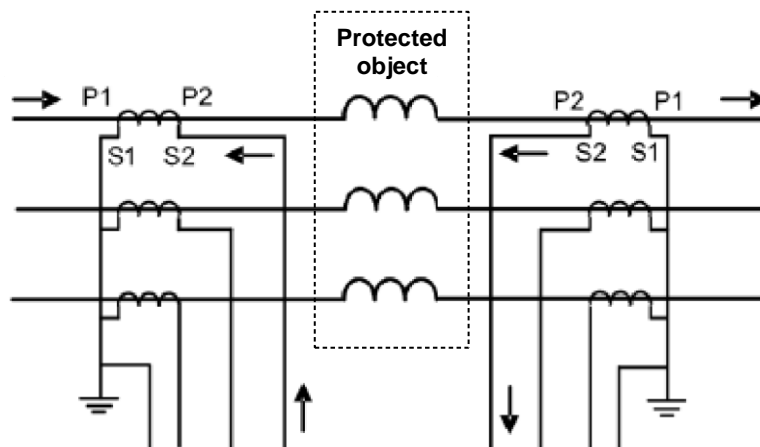

Fig. 12.19 CT connection Type 1

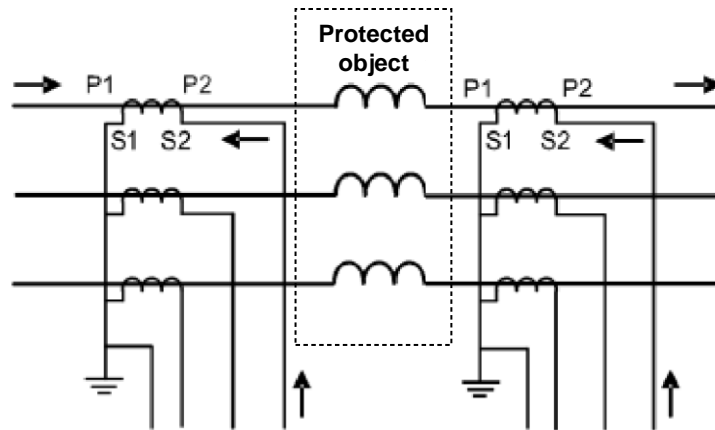

Fig. 12.20 CT connection Type 2

Winding 1 type, Winding 2 type, Clock number (Transformer vector group matching) The **Winding 1** parameter defines the connection type on the primary side of the protected object, which in this case is the generator (neutral point side) connected in Y configuration. The **Winding 2** parameter defines the connection type on the secondary side of the protected object, which in this case is the generator (outgoing voltage side) also connected in y configuration (galvanically the same as winding 1 side but including the generator stator winding). The **Clock number** parameter defines the angular difference in phase currents between the Winding 1 and Winding 2 side of the protected object. Since the protected object is a generator stator, where the only separating difference between the connection of Winding 1 and Winding 2 is the generator stator winding, the angular difference between Winding 1 and Winding 2 is zero (0).

Zro A elimination (Zero-sequence component elimination)

By using the Zro A elimination parameter, the zero-sequence component of the phase currents (at for instance earth faults occurring outside the protection area) is calculated and reduced for each phase current.

For the Y-y transformation (where the protected object is the generator stator) with Clock number 0, the **Zro A elimination** is not needed and the parameter is to be selected as **Not eliminated**. See Table 242 (Vector group of the transformer: **Yy0**) page 300 of ABB RET615 Technical Manual for details.

Restraint mode - Harmonic deblock 2 (Second harmonic blocking)

The transformer magnetizing inrush currents occur when energizing the transformer after a period of de-energization. The inrush current can be many times the rated current and the halving time can be up to several seconds. To the differential protection, the inrush current represents a differential current, which would cause the differential protection to operate almost always when the transformer is connected to the network. Typically, the inrush current contains a large amount of second harmonics. Blocking the operation of the TR2PTDF biased low stage at a magnetizing inrush current is based on the ratio of the amplitudes of the second harmonic digitally filtered from the differential current and the fundamental frequency (I_{d2f} / I_{d1f}). The operation of the biased stage on the concerned phase is blocked if the weighted ratio of that phase is above the set blocking limit **Start value 2.H** and if blocking is enabled through the **Restraint mode** parameter.

The Second harmonic blocking can also be enabled and disabled with the **Harmonic deblock**

2 parameter. See ABB RET615 Technical Manual for details. In case of any uncertainty it is highly recommended to keep the Harmonic deblock (2/5) and Waveform blocking parameters default.

Restraint mode – Harmonic deblock 5 (Fifth harmonic blocking)

The inhibition of TR2PTDF operation in the situations of overexcitation is based on the ratio of the fifth harmonic and the fundamental component of the differential current (I_{d5f}/I_{d1f}). The ratio is calculated separately for each phase without weighting. If the ratio exceeds the setting value of **Start value 5.H** and if blocking is enabled through the **Restraint mode** parameter, the operation of the biased stage of TR2PTDF in the concerned phase is blocked. At dangerous levels of overvoltage, which can cause damage to the transformer, the blocking can be automatically eliminated. If the ratio of the fifth harmonic and the fundamental component of the differential current exceeds the **Stop value 5.H** parameter, the blocking removal is enabled. The enabling and disabling of deblocking feature can also be done through the **Harmonic deblock 5** parameter. See ABB RET615 Technical Manual for details. In case of any uncertainty it is highly recommended to keep the Harmonic deblock (2/5) and Waveform blocking parameters default.

Restraint mode (Waveform blocking)

The biased low stage can always be blocked with waveform blocking. The stage can not be disabled with the **Restraint mode** parameter. This algorithm has two parts. The first part is intended for external faults while the second is intended for inrush situations. The algorithm has criteria for a low current period during inrush where also the differential current (not derivative) is checked.

Low operate value (Biased low stage)

The current differential protection needs to be biased because the possible appearance of a differential current can be due to something else than an actual fault in the generator. The false differential current can be caused by:

- CT errors.
- CT saturation at high currents passing through the generator.

The operating characteristic of the biased low stage is determined by **Low operate** value, **Slope section 2** and the setting of the second turning point of the operating characteristic curve, **End section 2** (the first turning point and the slope of the last part of the characteristic are fixed). The settings are the same for all the phases. When the differential current exceeds the operating value determined by the operating characteristic, the differential function awakes. If the differential current stays above the operating value continuously for a suitable period, which is 1.1 times the fundamental cycle, the function operates (trips). The stage can be blocked internally by the second or fifth harmonic restraint.

The **Low operate** value of the biased stage of the differential function is determined according to the operation characteristic (see Fig. 12.21): **Low operate value** = I_{d1} Slope section 2 is determined correspondingly:

$$\text{Slope section 2} = I_{d2} / I_{b2} \times 100\%$$

The second turning point **End section 2** can be set in the range of 100 percent to 500 percent.

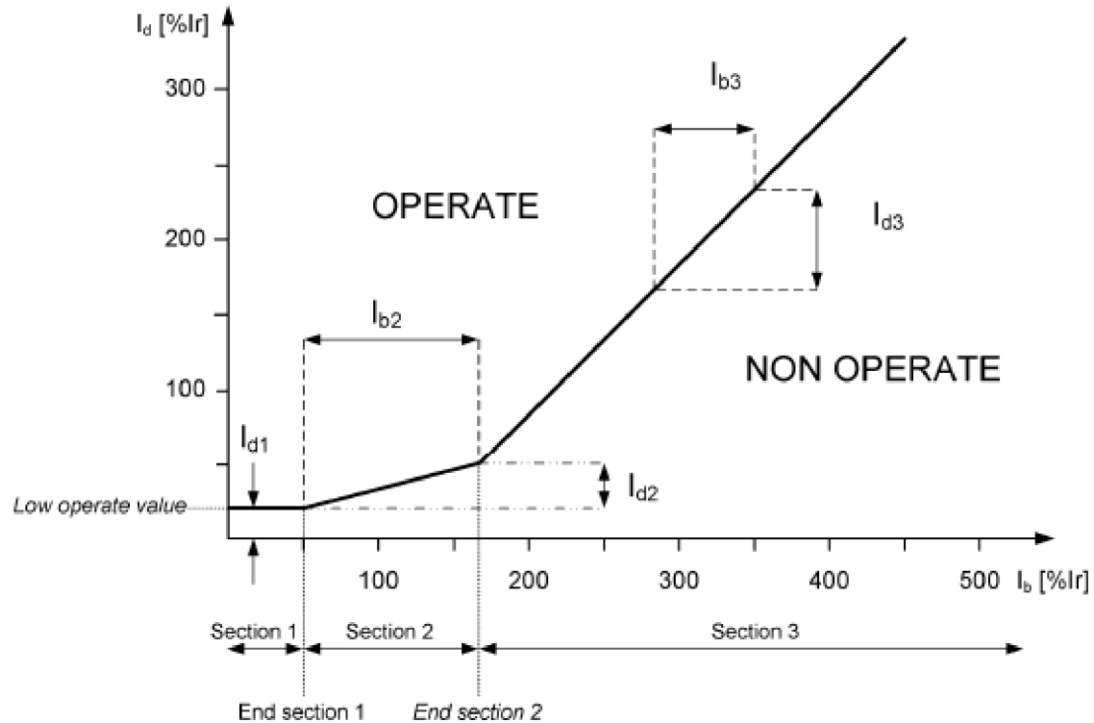

Fig. 12.21 Operating characteristics for biased operation of TR2PTDF

The slope of the differential function's operating characteristic curve varies in the different sections of the range (see Fig. 12.22):

- ✦ In section 1, where $0 \text{ percent } I_r < I_b < \text{End section 1}$, End section 1 being fixed to 50 percent I_r , the differential current required for tripping is constant. The value of the differential current is the same as the Low operate value selected for the function. Low operate value basically allows the no-load current of the generator and small inaccuracies of the current transformers, but it can also be used to influence the overall level of the operating characteristic.
- ✦ In section 2, where $\text{End section 1} < I_b/I_n < \text{End section 2}$, is called the influence area of Slope section 2. In this section, variations in the starting ratio affect the slope of the characteristic, that is, how big a change in the differential current is required for tripping in comparison with the change in the load current. The starting ratio should consider CT errors. Too high a starting ratio should be avoided, because the sensitivity of the protection for detecting inter-turn faults depends basically on the starting ratio.
- ✦ In section 3, where $I_b/I_n > \text{End section 2}$, the slope of the characteristic is constant. The slope is 100%, which means that the increase in the differential current is equal to the corresponding increase in the biasing current.

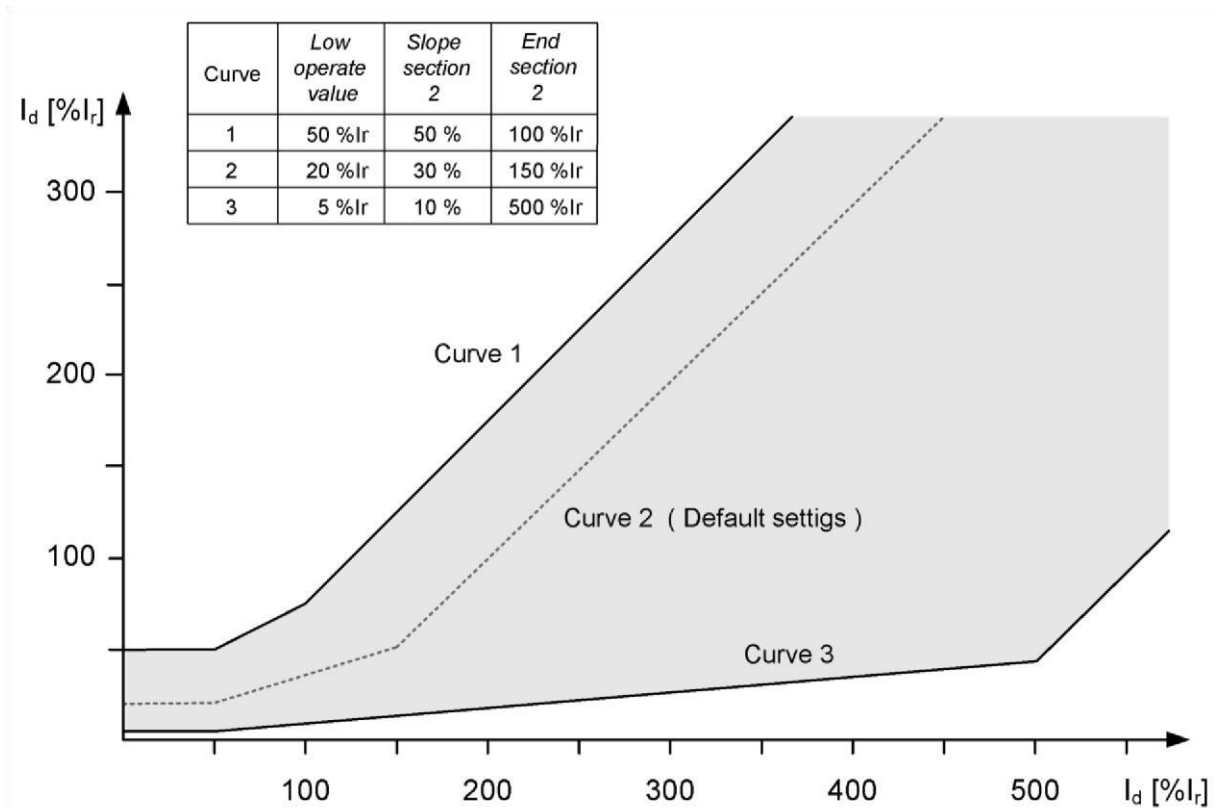

Fig. 12.22 Setting range for biased low stage

If the biasing current drops below 30 percent of the differential current a fault has most likely occurred in the area protected by TR2PTDF. Then the internal blocking signals of the biased stage are inhibited.

High operate value (Instantaneous high stage)

The instantaneous high stage operation can be enabled and disabled with the **Enable high set** setting.

The operation of the instantaneous high stage is not biased. The instantaneous stage operates (trips) when the amplitude of the fundamental frequency component of the differential current exceeds the set **High operate value** or when the instantaneous value of the differential current exceeds 2.5 times the value of **High operate value**. The factor 2.5 ($=1.8 \times \sqrt{2}$) is due to the maximum asymmetric short circuit current.

If the biasing current is small compared to the differential current, a fault has occurred in the area protected by TR2PTDF. Then the operation value set for the instantaneous stage is automatically halved and the internal blocking signals of the biased stage are inhibited.

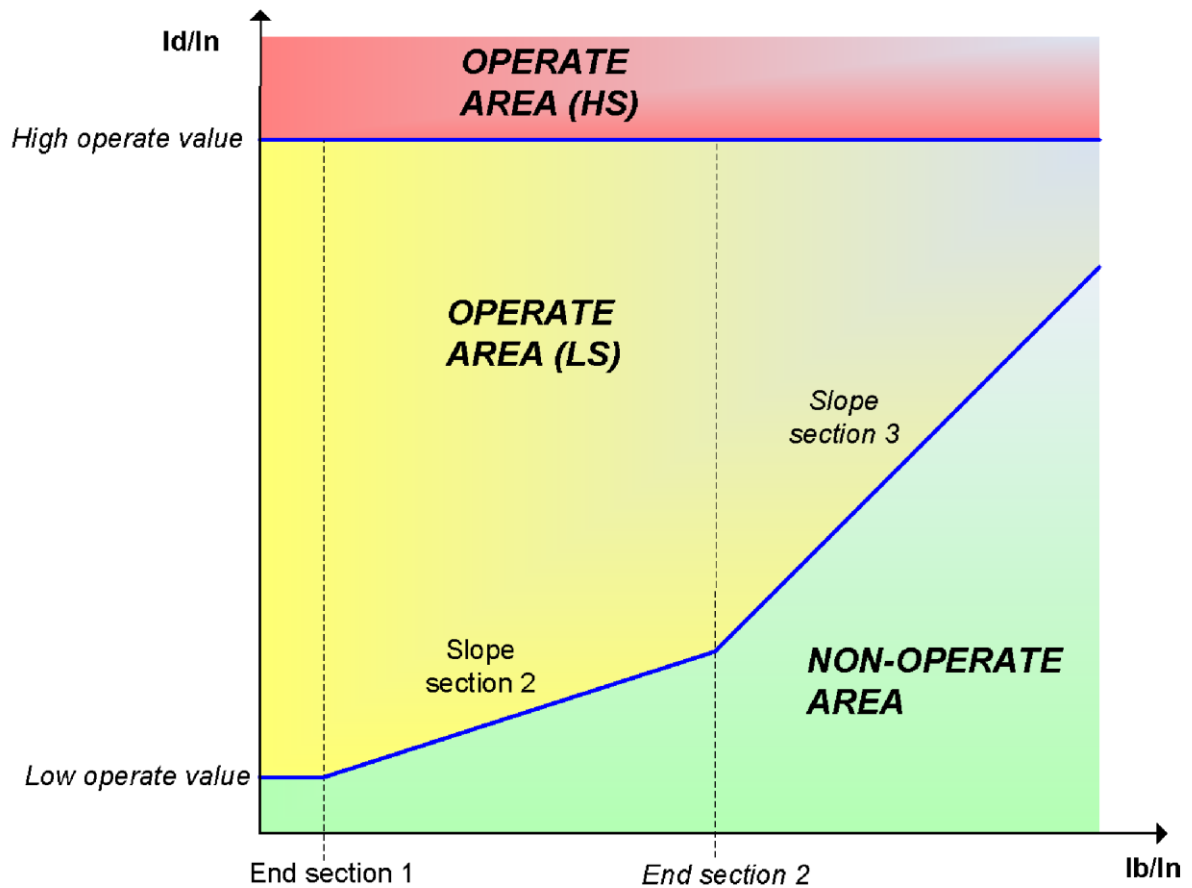

Fig. 12.23 Operating characteristics (LS=biased low stage, HS=instantaneous high stage)

The internal blocking signals of the differential function do not prevent the operate signal of the instantaneous differential current stage.

LAB SESSION 13

To perform the differential protection of a Dy connected Transformer

13.1 General description

The differential protection is used to protect the equipment against internal faults. It measures the difference of currents between the incoming and outgoing sides of the equipment, in case of an internal fault this difference is non-zero thus the relay issues the trip signal to the circuit breaker. Therefore, the zone of protection of the differential relay is between the installed CTs at the incoming and outgoing ends.

13.2 Equipment List

- Differential Relay Trainer
- 3 Phase Transformer
- 3 phase AC Variable Power Supply
- Load Resistors
- Multimeters
- Connecting Wires

13.3 Theory

The differential protection of a Dy connected transformer is not simple. If the CTs are connected in Y on both sides of the equipment then it results in the malfunctioning of relay even at normal load conditions. The line currents on the delta and star side of the transformer are different in magnitude as well as phase angle, this means that there is a spill current in the relay even at normal condition thus causing it to malfunction. In order to avoid the undesired tripping of relay, the magnitude and phase difference have to be removed. The phase difference is removed by connecting the CT secondary windings in opposite connection as compared to the transformer winding, that is, CT secondary on the delta side is connected in Y and vice versa. The magnitude difference is removed by the use of another set of CTs called as the interposing CT. As an alternate approach, both the magnitude and the phase difference can be corrected by the use of interposing CT.

13.4 Procedure

- Set the low operate value to 20% in the relay.
- Connect the primary side of the transformer in delta and the secondary side in Y.
- Connect the CTs on both side of the transformer in Y. Do not forget that the CT output on one side of the transformers must be 180 degrees out of phase as compared to the other side (Refer to figure 13.1).
- Now connect the power supply to the circuit and gradually increase the supply voltage to 400V.
- Take observations regarding the spill current of the relay.
- Turn off the power supply.
- Now connect the CT connections on delta and Y side of the transformer in arrangement shown in figure 13.2 and 13.3 respectively.
- Turn on the supply and make sure the supply voltage does not increase 80V.
- Set the value of fault resistor to be 50 ohms.
- Now connect the fault resistor on the Y side of the transformer to simulate a L-L fault.
- Observe the tripping of the relay.

- Reset the relay.

13.5 Circuit Diagrams

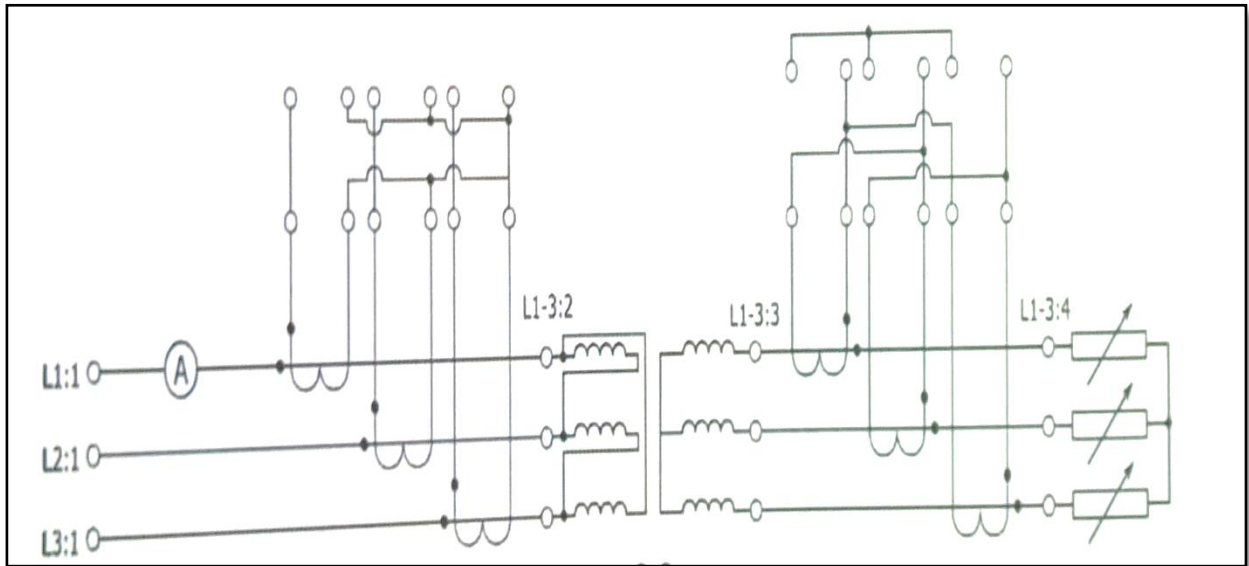

Figure 13.1: Y connection of CTs for a Dy Transformer

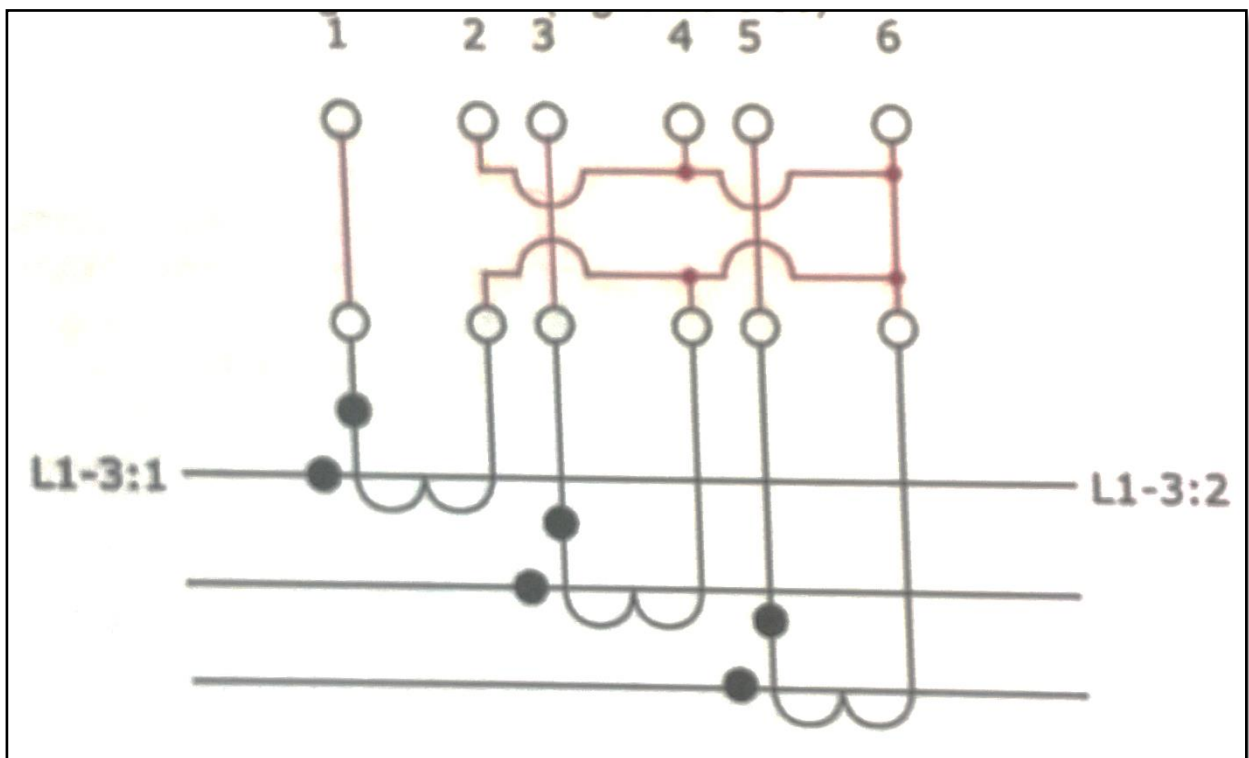

Figure 13.2: CT connections for Delta side of the transformer

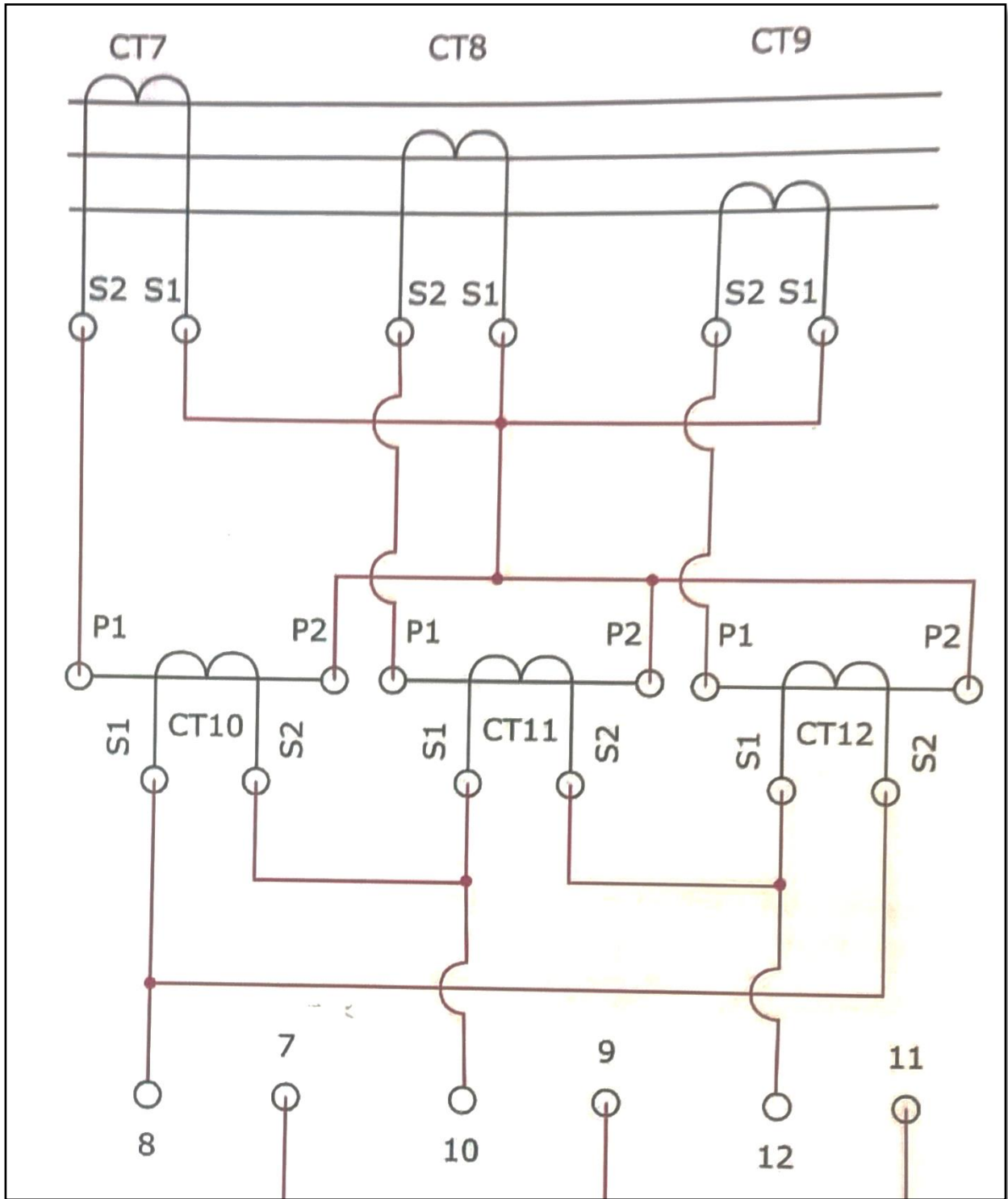

Figure 13. 3: CT connections for the Y side of the transformer

13.5 Observations

For the figure given below, fill out table 13.1 for which faults the relay will trip.

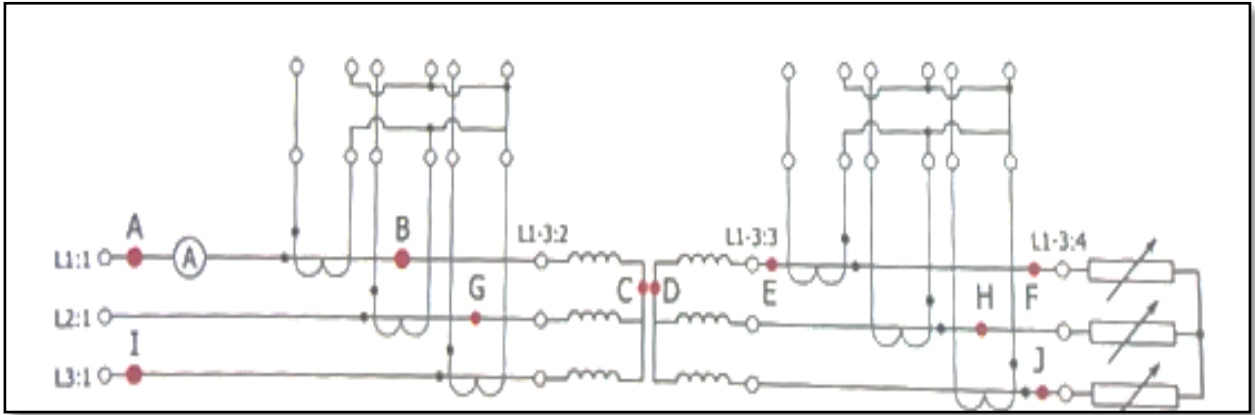

Figure 13. 4: Fault Positions for Observation

S. No	Fault Resistance Between	Trip/ Restrain
1	C-F	
2	A-E	
3	B-G	
4	J-D	
5	F-H	
6	C-D	
7	B-E	

13.6 Questions

- Will the relay trip if the fault is applied between F-H? Explain.

- Will the relay trip if there is an unbalanced load connected to it?

- What are interposing CTs?



Course Code and Title: _____

Laboratory Session: No. _____ Date: _____

Psychomotor Domain Assessment Rubric-Level P3					
Skill Sets	Extent of Achievement				
	0	1	2	3	4
Equipment Identification Sensory skill to identify equipment and/or its component for a lab work. 10%	Not able to identify the equipment. 0	--	--	--	Able to identify equipment as well as its components. 40
Equipment Use Sensory skills to describe the use of the equipment for the lab work. 15%	Never describes the use of equipment. 0	Rarely able to describe the use of equipment. 15	Occasionally describe the use of equipment. 30	Often able to describe the use of equipment. 45	Frequently able to describe the use of equipment. 60
Procedural Skills Displays skills to act upon sequence of steps in lab work. 15%	Not able to either learn or perform lab work procedure. 0	Able to slightly understand lab work procedure and perform lab work. 15	Able to somewhat understand lab work procedure and perform lab work. 30	Able to moderately understand lab work procedure and perform lab work. 45	Able to fully understand lab work procedure and perform lab work. 60
Response Ability to imitate the lab work on his/her own. 15%	Not able to imitate the lab work. 0	Able to slightly imitate the lab work. 15	Able to somewhat imitate the lab work. 30	Able to moderately imitate the lab work. 45	Able to fully imitate the lab work. 60
Observation's Use Displays skills to perform related mathematical calculations using the observations from lab work. 15%	Not able to use lab work observations into mathematical calculations. 0	Able to slightly use lab work observations into mathematical calculations. 15	Able to somewhat use lab work observations into mathematical calculations. 30	Able to moderately use lab work observations into mathematical calculations. 45	Able to fully use lab work observations into mathematical calculations. 60
Safety Adherence Adherence to safety procedures. 10%	Doesn't adhere to safety procedures. 0	Slightly adheres to safety procedures. 10	Somewhat adheres to safety procedures. 20	Moderately adheres to safety procedures. 30	Fully adheres to safety procedures. 40
Equipment Handling Equipment care during the use. 10%	Doesn't handle equipment with required care. 0	Rarely handles equipment with required care. 10	Occasionally handles equipment with required care. 20	Often handles equipment with required care. 30	Handles equipment with required care. 40
Group Work Contributes in a group-based lab work. 10%	Never participates. 0	Rarely participates. 10	Occasionally participates and contributes. 20	Often participates and contributes. 30	Frequently participates and contributes. 40
Total Points (Out of 400)					
Weighted CLO (Psychomotor Score)		(Points /4)			
Remarks					
Instructor's Signature with Date:					



Course Code and Title: _____

Laboratory Session: No. _____ Date: _____

Psychomotor Domain Assessment Rubric-Level P3					
Skill Sets	Extent of Achievement				
	0	1	2	3	4
Equipment Identification Sensory skill to identify equipment and/or its component for a lab work. 10%	Not able to identify the equipment. 0	--	--	--	Able to identify equipment as well as its components. 40
Equipment Use Sensory skills to describe the use of the equipment for the lab work. 15%	Never describes the use of equipment. 0	Rarely able to describe the use of equipment. 15	Occasionally describe the use of equipment. 30	Often able to describe the use of equipment. 45	Frequently able to describe the use of equipment. 60
Procedural Skills Displays skills to act upon sequence of steps in lab work. 15%	Not able to either learn or perform lab work procedure. 0	Able to slightly understand lab work procedure and perform lab work. 15	Able to somewhat understand lab work procedure and perform lab work. 30	Able to moderately understand lab work procedure and perform lab work. 45	Able to fully understand lab work procedure and perform lab work. 60
Response Ability to imitate the lab work on his/her own. 15%	Not able to imitate the lab work. 0	Able to slightly imitate the lab work. 15	Able to somewhat imitate the lab work. 30	Able to moderately imitate the lab work. 45	Able to fully imitate the lab work. 60
Observation's Use Displays skills to perform related mathematical calculations using the observations from lab work. 15%	Not able to use lab work observations into mathematical calculations. 0	Able to slightly use lab work observations into mathematical calculations. 15	Able to somewhat use lab work observations into mathematical calculations. 30	Able to moderately use lab work observations into mathematical calculations. 45	Able to fully use lab work observations into mathematical calculations. 60
Safety Adherence Adherence to safety procedures. 10%	Doesn't adhere to safety procedures. 0	Slightly adheres to safety procedures. 10	Somewhat adheres to safety procedures. 20	Moderately adheres to safety procedures. 30	Fully adheres to safety procedures. 40
Equipment Handling Equipment care during the use. 10%	Doesn't handle equipment with required care. 0	Rarely handles equipment with required care. 10	Occasionally handles equipment with required care. 20	Often handles equipment with required care. 30	Handles equipment with required care. 40
Group Work Contributes in a group-based lab work. 10%	Never participates. 0	Rarely participates. 10	Occasionally participates and contributes. 20	Often participates and contributes. 30	Frequently participates and contributes. 40
Total Points (Out of 400)					
Weighted CLO (Psychomotor Score)		(Points /4)			
Remarks					
Instructor's Signature with Date:					